

rava™

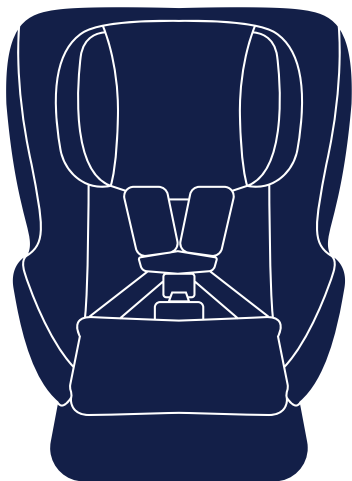

AVA®

Thank you!

You've just purchased a Nuna product, and you can be sure that your child is getting the best there is. Our products are expertly engineered for safety, with luxury fabrics and sophisticated style.

Whatever made you fall in love with Nuna, rest assured your adventures with your little one will be easier from now on, freeing you to enjoy more happy family moments together.

Easy Installation

Our products are designed to make your life easier, so installing this child restraint doesn't require outside assistance. While we encourage the use of Certified Child Passenger Safety Technicians to ensure you have installed the seat correctly, you can install the child restraint in your vehicle without these professionals by carefully reading and following these instructions.



 **WARNING:** Carefully read and understand all instructions and warnings in this manual, and those labeled on your child restraint. Failure to do so can result in the **SERIOUS INJURY** or **DEATH** of your child. Store manual in pocket at rear of base for future use.

Contents

Important Information

Product Information/Registration	4
Safety Warnings	6
Car Seat Use after a Crash	8
Vehicle Compatibility	9

Child Restraint Overview

Features Overview	16
Features Usage	18
Child Usage Requirements	40

Rear Facing Installation

Rear Facing Setup	42
Using Vehicle Lap/Shoulder Belt	44
Using Lower Anchor Belt	46
Using Vehicle Lap Belt	48

Forward Facing Installation

Forward Facing Setup	50
Using Vehicle Lap/Shoulder Belt	52
Using Lower Anchor Belt	54
Using Vehicle Lap Belt	56

Securing Child in Child Restraint	58
-----------------------------------	----

Aircraft Installation	61
-----------------------	----

Cleaning and Maintenance	62
--------------------------	----

Product Information/ Registration

Model Number: _____

Manufactured in (date): _____

Product Registration

Please fill in the above information. The model number and the manufactured in date are located on a label on the bottom of your child restraint. Fill out the prepaid registration postcard attached to the seat pad and mail it today.

Child restraints could be recalled for safety reasons. Register your child restraint so you can be notified in case of a recall. Send your name, address, e-mail/ phone number if available and the restraint's model number and manufacturing date to:

Nuna Baby Essentials Inc.
70 Thousand Oaks Blvd.
Morgantown, PA 19543

or call 1.855.NUNA.USA

Recall Information

For recall information, call the U.S. Government's Vehicle Safety Hotline at: 1.888.327.4236 (TTY: 1.800.424.9153) or go to <http://www.NHTSA.gov>

Limited Warranty

We have purposely designed our high-quality products so that they can grow with both your child and your family. Because we stand by our product, our gear is covered by a custom limited warranty per product, starting from the day it was purchased. Please have the proof of purchase, model number and manufactured in date available when you contact us.

For warranty information please visit:
www.nunababy.com/warranty

Contact

For replacement parts, service, or additional warranty questions, please contact our customer service department.

In the USA:
infousa@nunababy.com
www.nunababy.com
1.855.NUNA.USA

⚠️ WARNING
DEATH OR SERIOUS INJURY CAN OCCUR.

Never leave child unattended in this child restraint.

Do not allow anyone who has not read the instructions to install or use this child restraint.

Never leave child restraint unsecured in your vehicle even when it is unoccupied. In a crash, it could become a projectile and injure other vehicle occupants.

To avoid strangulation, do not allow children to play with vehicle or child restraint belts or straps. If possible, move unused belts out of reach.

Cover the child restraint when your vehicle is parked in sunlight. Parts of a child restraint can become very hot if left in the sun, and can burn a child's skin. Check for hot parts before putting your child in the child restraint.

Do not use any products or accessories with this child restraint unless they are approved by Nuna USA for use with this child restraint. Doing so may be unsafe and may void the warranty.

Do not use child restraint if it has frayed or cut harness straps, or is damaged in any way. To find out if damaged parts are replaceable, call 1-855-NUNA-USA.

Never modify any part of the child restraint.

NEVER use a car seat that has been involved in a moderate to severe crash.

See page 8 to learn the difference between a minor and moderate to severe crash.

Do not use child restraint if it is more than 10 years old. Check the manufacturer's label or stamped 'do not use after' date on the bottom of the child restraint base.

Car Seat Use after a Crash

The National Highway Traffic Safety Administration (NHTSA) recommends that car seats be replaced following a moderate or severe crash. Car seats do not automatically need to be replaced following a minor crash.

A minor crash is one in which **ALL** of these apply:

- The vehicle was able to be driven away from the crash site.
- The vehicle door nearest to the car seat was not damaged.
- None of the passengers in the vehicle sustained any injuries in the crash.
- If the vehicle has air bags, none of the air bags deployed during the crash; and
- There is no visible damage to the car seat.

Any crash that does not meet all of the above criteria for a minor crash is considered a moderate to severe crash. **NEVER** use a car seat that has been involved in a moderate to severe crash.

Information from nhtsa.gov

Vehicle Compatibility

⚠ WARNING: You **MUST** read and understand **ALL** child restraint related instructions and warnings in your vehicle owner's manual to correctly and safely use this child restraint in your vehicle.

This child restraint can **ONLY** be installed on vehicle seats that face forward. **DO NOT** install in seats that face to the sides or rear of the vehicle.

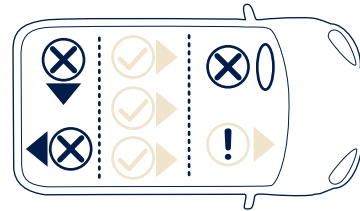

⚠ WARNING: SERIOUS INJURY OR DEATH MAY OCCUR. **NEVER** install this child restraint rear facing in a vehicle seating position with a frontal air bag unless it is turned off. If your vehicle is equipped with front passenger side air bags, check your vehicle owner's manual for child restraint installation instructions.

IMPORTANT: According to accident statistics, children are safer when properly restrained in the rear seating positions than in the front seating positions.

This child restraint can be installed without vehicle belts, by connecting the restraint's lower anchor belts to the lower anchorages in your vehicle.

LATCH (Lower **A**nchors and **T**ether for **C**hildren) is a system for installing a child restraint in a vehicle without using the vehicle belts. Refer to your vehicle owner's manual to determine if your vehicle is equipped with **LATCH**, and how to correctly use **LATCH** to install this child restraint in your vehicle.

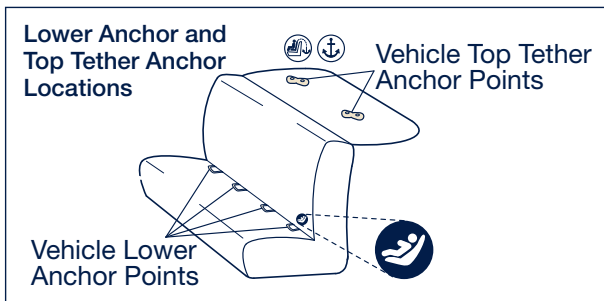

This child restraint is designed to be used with lower **LATCH** anchors at the standard spacing of 11 inches (28 cm). **LATCH** lower vehicle anchor points are defined as 11 inches (28 cm) from the center of one **LATCH** anchor to the center of another **LATCH** anchor.

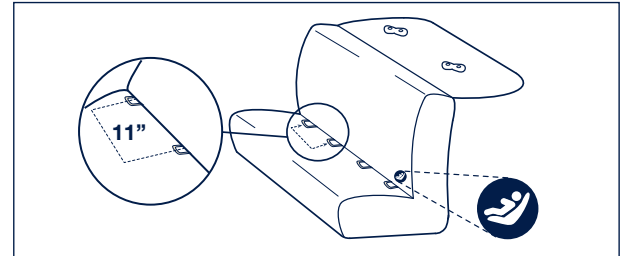

WARNING: DO NOT USE the **LATCH** lower anchor belts to attach this child restraint rear facing when restraining a child weighing over 35 lb (15.9 kg) or forward facing when restraining a child weighing over 40 lb (18 kg). Check your vehicle owner's manual for tether anchor weight limits.

The restraint's tether strap should be used for **ALL** forward facing installations, as it provides a more secure installation.

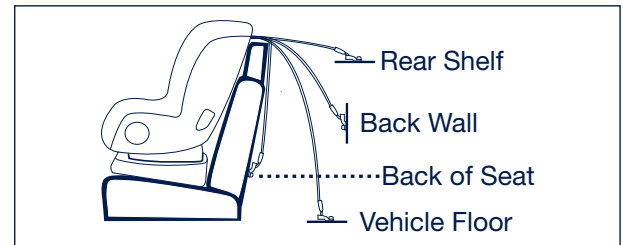

WARNING: NEVER use a child restraint in a vehicle seating position where it cannot be correctly secured. An incorrectly installed child restraint will not protect your child in a crash.

The following types of vehicle belts **CAN BE USED** to install this child restraint.

1 - Lap/Shoulder Belt

2 - Lap Belt Only

Belts **MUST** be able to be locked.

Refer to vehicle owner's manual to determine if the belts in your vehicle lock by switching the seat belt's retractor or they have a locking latch plate that locks the vehicle's seat belts so they will not move freely.

If the belt cannot be locked using one of these methods, contact Nuna Customer Service for a locking clip.

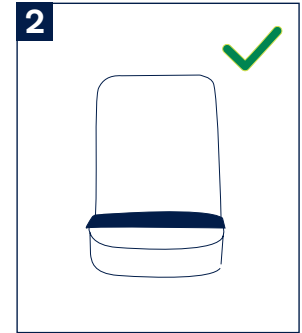
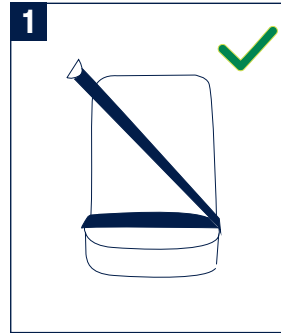

Vehicle belts that **CANNOT BE USED** with your child restraint:

The following types of vehicle belts **MUST NOT** be used to install this child restraint. They will not provide a secure, safe installation. Refer to your vehicle owner's manual for which seating positions in your vehicle can be used to install this child restraint using vehicle belts or **LATCH**.

1 - Motorized Belts (Automatic)

These should not be used unless the shoulder belt can be removed, the lap belt is locked and use is allowed by the vehicle manufacturer.

2 - Dual Retractor Lap/Shoulder Belts

If allowed by the manufacturer, the lap belt only may be used to secure the child restraint in accordance with this manual and the vehicle's manual.

3 - Non-Locking (ELR) Lap Belts

This belt locks in a crash or sudden stop and should only be used with a belt shortening clip. Contact your vehicle manufacturer if needed.

4 - Airbag/Inflatable Belts

This belt cannot be used to install this child restraint.

5 - Door Mounted Belts

This belt cannot be used to install this child restraint.

6 - Lap Belts forward of Seat Bight

This belt (where the seat bottom and back meet) cannot be used to install this child restraint.

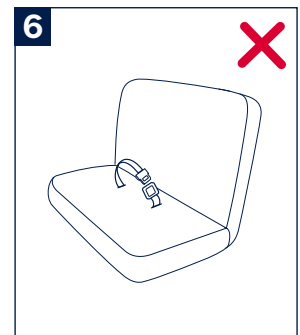
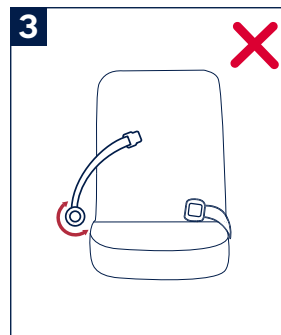
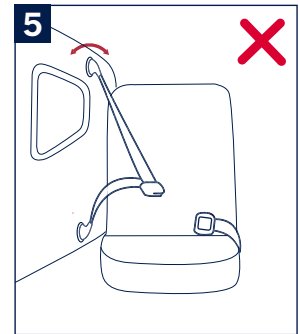
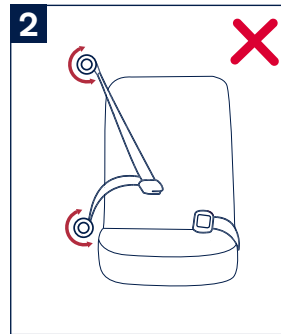
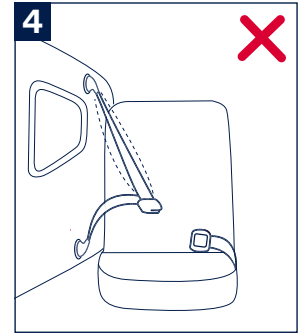
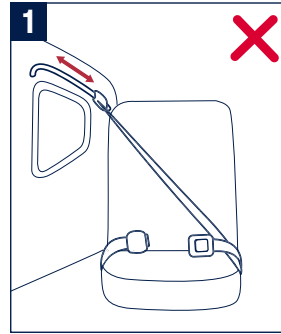

Features Overview

- | | | | |
|---|---|----|----------------------|
| 1 | Shoulder Harness Pads | 7 | Cup Holder |
| 2 | Harness Buckle | 8 | Hip Harness Pads |
| 3 | Crotch Pad | 9 | Buckle Tongue Holder |
| 4 | Harness Release Button (under soft goods) | 10 | Chest Clip |
| 5 | Harness Adjuster Strap | 11 | Infant Insert |
| 6 | Calf Support | 12 | Head Insert |
| | | 13 | Head Support |
| | | 14 | Harness Strap |
| | | 15 | Seat Cover |

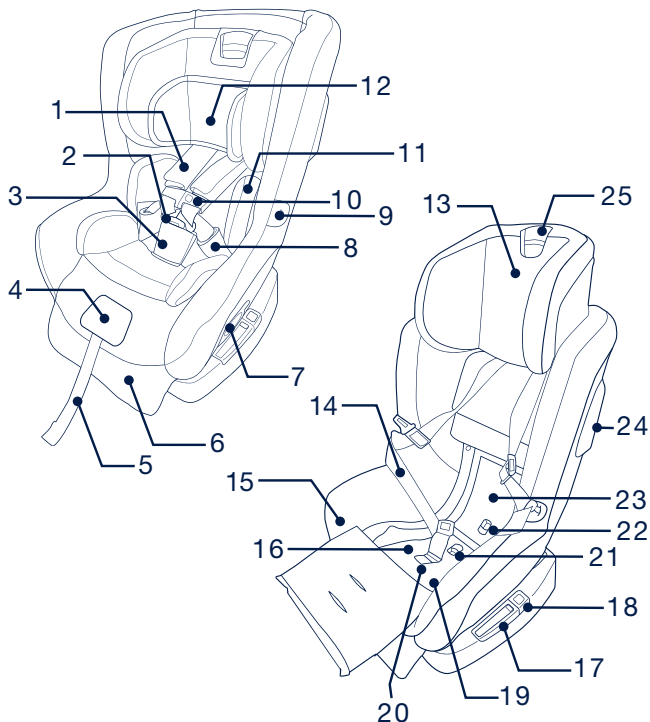

- | | | | |
|----|---|----|-----------------------------------|
| 16 | Lower Anchor Belt Storage (underneath door) | 24 | Side Impact Protection (SIP) pods |
| 17 | Recline Position Indicator | 25 | Head Support Button |
| 18 | Recline Button | 26 | Tether Strap Adjuster |
| 19 | Rear Facing True Tension Door | 27 | Tether Strap |
| 20 | Crotch Belt Plate | 28 | Tether Hook |
| 21 | Rear Facing True Tension Button | 29 | Lower Anchor Belt |
| 22 | Forward Facing True Tension Button | 30 | Lower Anchor Connectors |
| 23 | Forward Facing True Tension Door | 31 | Instruction Manual Storage |
| | | 32 | Lower Anchor Adjuster |

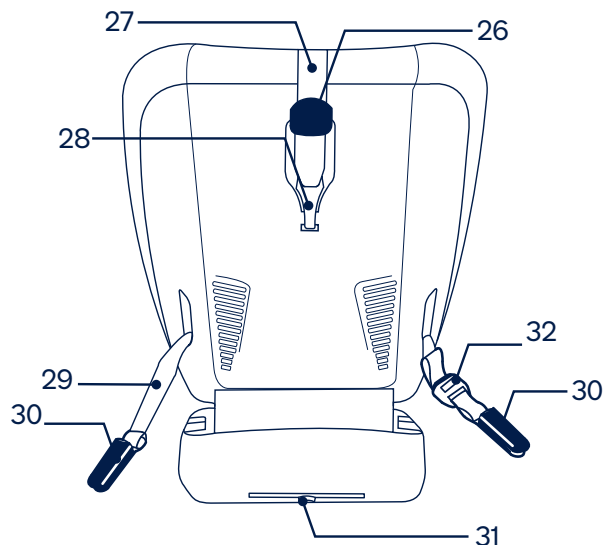

Feature Usage

Harness Use

1 - To Loosen Harness

Slide your finger under the seat soft goods and press down on harness release button while pulling forward on the harness straps.

2 - To Open Chest Clip

Press button on front of clip and pull clip apart.

3 - To Open Harness Buckle

Press red button on front of buckle and pull out buckle tongues.

4 - To Use Buckle Tongue Holders

Loosen and unfasten harness. Place buckle tongues in holders.

5 - To Fasten Chest Clip

Push chest clip halves together until they click. Pull to check. (1)

To Fasten Buckle

Insert buckle tongues firmly into buckle until they click. Pull up on tongues to ensure they are locked. (2)

6 - To Tighten Harness

Pull on harness adjuster strap.

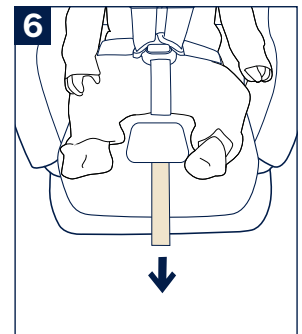
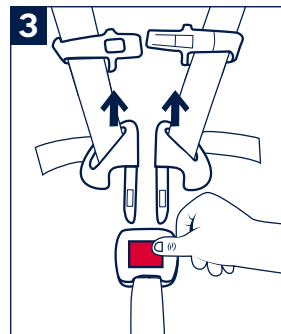
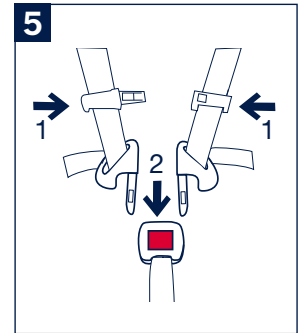
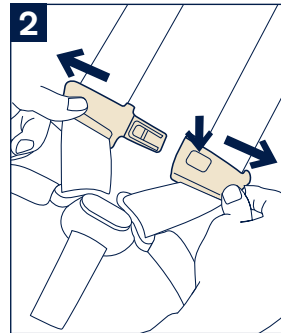
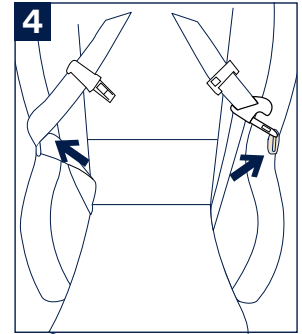
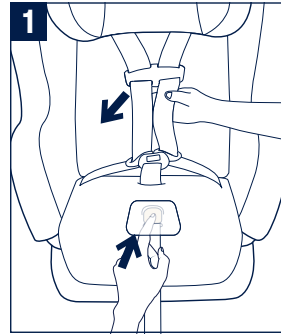

Head Insert Use

- 1 - The head insert may be used or removed for improved comfort or fit of any child.

Harness & Crotch Pad Use

- 2 - The harness pads are a comfort feature that may be used or removed for any child. Small infants may have better fit to harness with shoulder pads removed.

Head Support Adjustment

- 3 - With harness loose (p.18), squeeze head support button and move head support up or down to desired position.

Release button and slide head support slightly up or down to lock into appropriate use position.

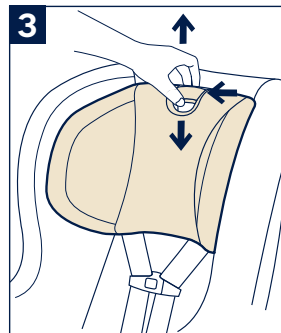
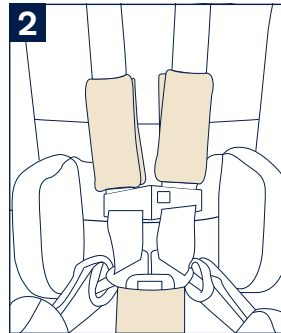
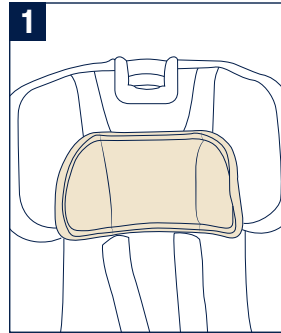

Infant Insert Use

The infant insert should be used for a child that is between 5–11 lb to improve the harness fit and recline angle for smaller infants.

You **MUST** use the infant insert if the harness straps are positioned **ABOVE** the child's shoulders and child weighs between 5–11 lb. The harness **MUST** be positioned **AT or JUST BELOW** the child's shoulders.

The head insert may be used or removed for improved comfort to child at any time.

To Install Infant Insert

- 1 - Pull harness buckle through slot in the bottom of infant insert.
- 2 - Route harness straps through gaps in sides of infant insert.
- 3 - Push infant insert firmly into child restraint.
- 4 - Make sure insert is properly positioned.

When properly installed, the infant insert will not interfere with harness straps or crotch belt. Crotch belt must be locked in inner position when infant insert is used.

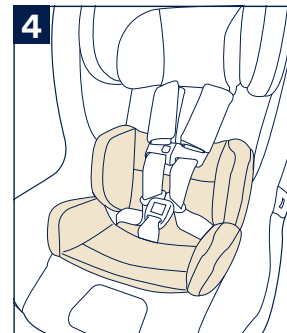
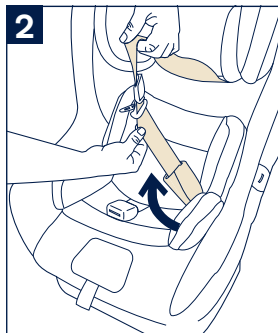
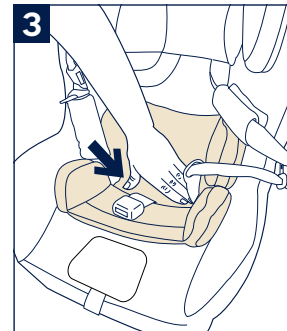
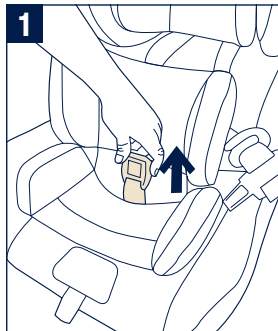

True Tension Door Use

This child restraint has two True Tension doors that aid in a simple and secure installation of the child restraint in your vehicle. They are located underneath the seat cover. The upper door (RED) is for forward facing use, and the lower door (BLUE) is for rear facing use.

Remove infant insert, loosen and unfasten harness (p.18), and retain with buckle tongue holders (p.18).

- 1 - Adjust head support to highest position, unfasten seat cover and pull to front of seat.
- 2 - Squeeze door release button for the appropriate True Tension door.
- 3 - Lift open True Tension door.
- 4 - Close True Tension door by pressing down firmly on door until both latches lock in place. Replace seat cover and reinstall infant insert if used (p.22).

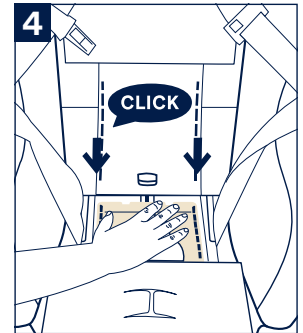
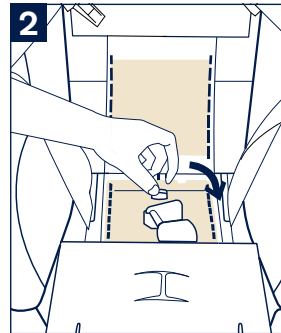
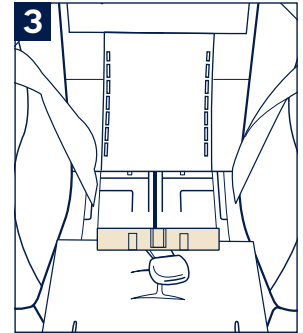
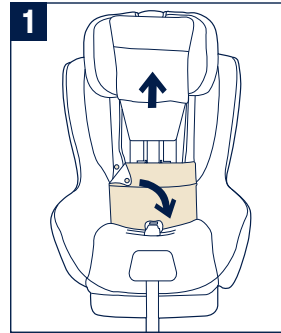

Crotch Belt Adjustment

The crotch belt has two positions. Use the position that is closest to, but not under your child.

Remove infant insert (p.22) and loosen and unbuckle harness (p.18).

- 1** - Unsnap seat cover and pull forward while pulling crotch buckle through slot in seat cover.
- 2** - Depress and slide crotch belt plate forward or backward and lock in desired position. Place buckle back through correct slot in seat cover and replace seat cover and infant insert (if using).

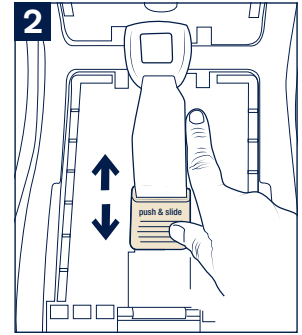
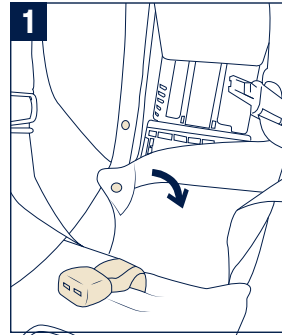

Lower Anchor Belt Storage and Use

The lower anchor belt, located in storage compartment under the rear facing True Tension door, can be used instead of a vehicle belt to install this child restraint. **The lower anchor belt must not be used rear facing if your child weighs more than 35 lb (15.9 kg), or forward facing if your child weighs more than 40 lb (18 kg).**

- 1 - To use lower anchor belt, open rear facing True Tension door (p.24), remove lower anchor belt, and lengthen by pressing adjuster button while pulling on belt.
- 2 - To connect lower anchor belt to lower anchors in vehicle, press connector firmly onto lower anchor and pull to check.
- 3 - To release lower anchor belt, press red button on end of connector while pulling on belt.
- 4 - To store, fold lower anchor adjuster and lower anchor belt, and place in storage compartment. Store other lower anchor belt in adjacent storage compartment. Tuck excess webbing.

When not in use, the lower anchor belt **MUST** be properly stored in lower anchor storage compartment under rear facing True Tension door, and **MUST NOT** interfere with latching of door.

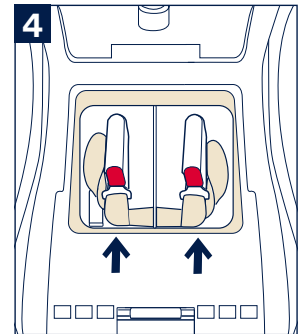
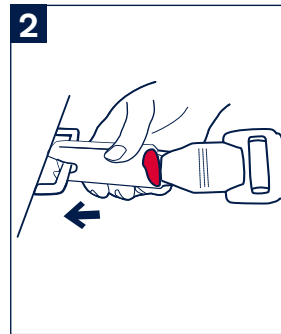
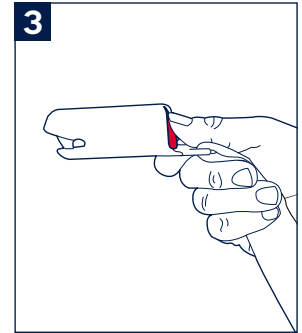
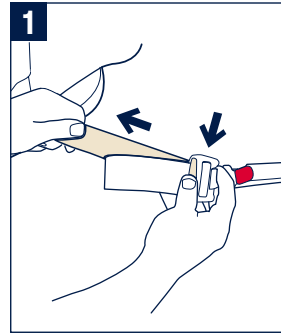

Cup Holder Use

- 1 - Pivot cup holder up and lock in use position.
- 2 - Push center of cup holder down to extend to opened position.
- 3 - While in the opened position, pull up on the cup holder to remove for washing OR remove for easier rear facing belt installation.
- 4 - To store, collapse cup holder and pivot down.

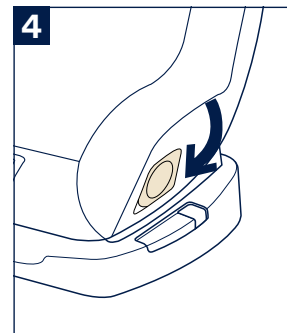
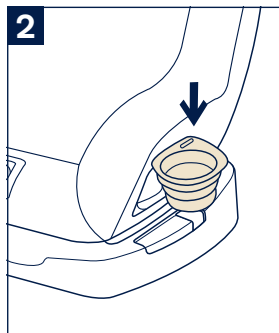
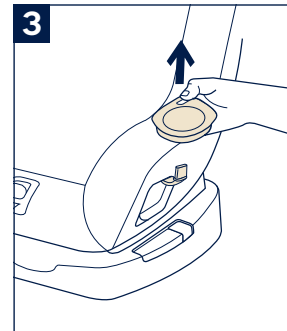
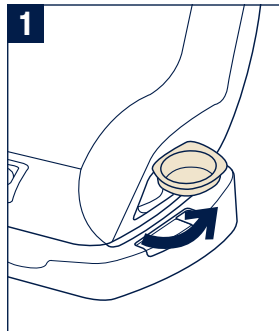

Cup holders must be opened to access belt path during rear facing installation of child restraint. Cup holders may be collapsed down against vehicle belt after belt installation.

DO NOT place glass or metal containers or hard or sharp objects in cup holder. In a crash they could cause serious injury.

Side Impact Protection (SIP) Use

SIP pods should only be used on the door side of the child restraint. If the child restraint is installed in the middle seat position the SIP pods should not be used.

- 1** - Pull out SIP pod from corner of stored position until it locks into position.
- 2** - To store, press button and push SIP pod into stored position.

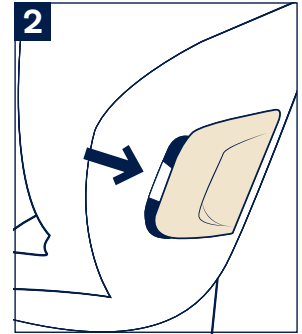
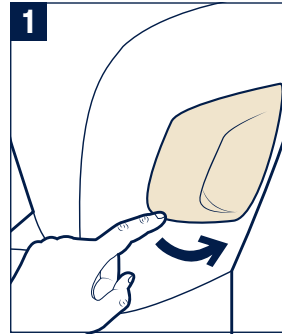

Calf Support Use

The calf support should be used to give your child more leg room and improve installation when rear facing and provide improved comfort when forward facing. It is designed to change position without damage if excessive force is applied.

- 1** - Recline child restraint to rear facing position 1 (**BLUE**).
- 2** - Move calf support to **USE** position by reaching under front of child restraint and rotating calf support down and forward.
- 3** - Move calf support to **STORAGE** position by pulling down on calf support to unlock, and rotating it to storage position.

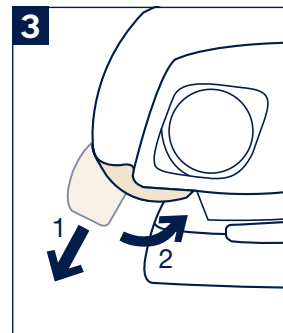
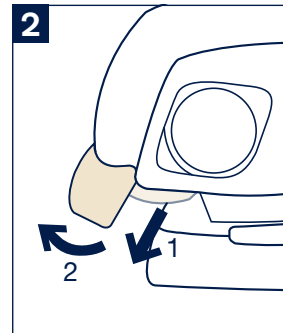
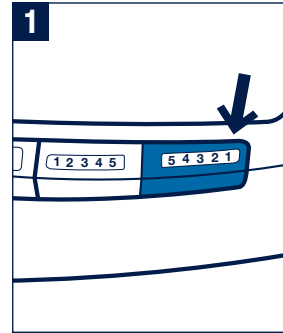

Tether Use

- 1 - To use, remove tether by loosening strap and unclipping from storage anchor.
- 2 - To extend tether for use, tilt tether adjuster and pull to lengthen.
- 3 - To store, attach tether to storage anchor and remove slack in strap by pulling on free end of strap. Loose strap should be stored in provided tether cover. When not in use, tether **MUST** be properly stored.

⚠ WARNING: ALWAYS USE TETHER

for forward facing installation if vehicle is equipped with a tether anchor point and vehicle requirements are met (see vehicle owner's manual). NEVER USE IN REAR FACING INSTALLATION.

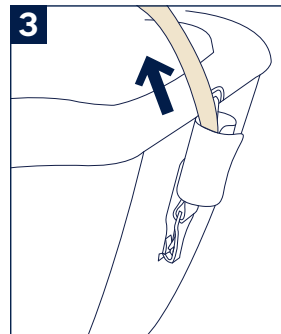
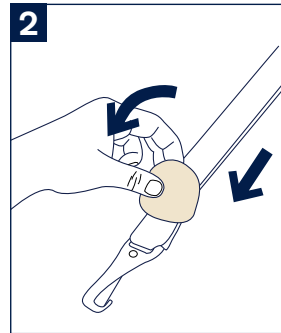
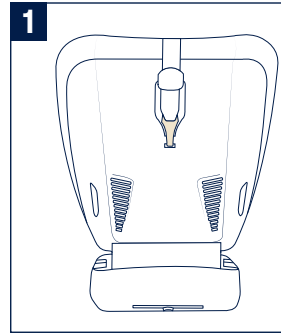

Recline Use

This child restraint has 10 recline positions. Recline can be changed for child's comfort or to improve installation of child restraint.

- 1 - Positions 1-5 (BLUE) are for rear facing use with children 5-50 lb (2.3-22.7 kg).

If infant's head falls forward, child restraint must be reclined more. Use Infant Insert with infants 5-11 lb (2.3-5 kg) to improve the recline angle for smaller infants.

- 2 - Positions 1-5 (RED) are for forward facing use with children 30-65 lb (13.6-30 kg).

To Adjust Recline

- 3 - Press recline button (1) on either side of the child restraint and move seat to desired recline position. (2)

Release recline button, and check that child restraint is locked in desired recline position.

To change recline position after installation, uninstall child restraint, select new recline position, and reinstall child restraint.

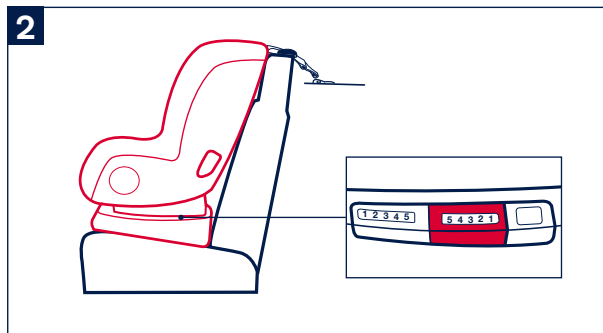
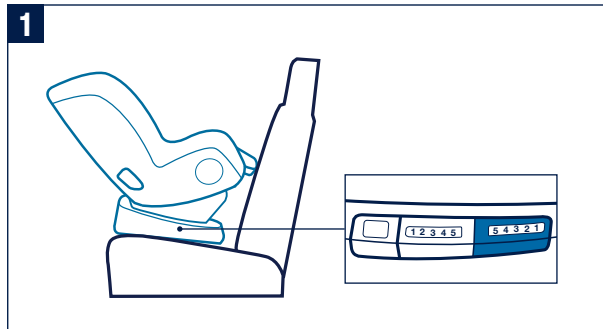

Child Usage Requirements

To use this child restraint, your child must meet **ALL** of the following weight and height requirements below:

Rear Facing Weight: 5–50 lb (2.3–22.7 kg)

Rear Facing Height: 18–49 in. (46–125 cm)

Forward Facing Weight: 30–65 lb (13.6–30 kg)

Forward Facing Height: 34–49 in. (87–125 cm)

The infant insert (p.22) is only for use with infants who weigh between 5–11 lb (2.3–5 kg).

Rear Facing Installation

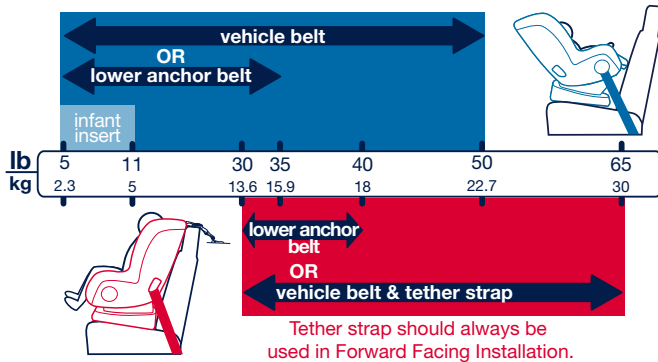

Forward Facing Installation

⚠ WARNING: Use either vehicle seat belt or lower anchors. Never use both methods to install child restraint.

Rear Facing Installation

Birth to 2+ years old, 5–50 lb (2.3–22.7 kg), 18–49 in. (46–125 cm)

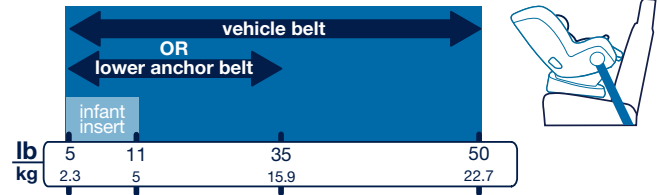

The American Academy of Pediatrics recommends children should ride rear facing for as long as possible up to 2 years in age, or until they reach maximum height and weight for their seat.

Rear Facing Setup

Before install, store tether strap.

Move the calf support to the use position (p.34).

- 1 - Place child restraint rear facing in a compatible vehicle seat (p.8).
- 2 - Select desired rear facing recline position 1-5 (BLUE) (p.38).

If infant's head falls forward, child restraint must be reclined more. Use infant insert with infants 5-11 lb (2.3-5 kg) to improve the recline angle for smaller infants.

Pivot cup holders to **USE** position to access rear facing belt path (p.30). If desired, cupholders can be removed for easier access to rear facing belt path.

- 3 - Loosen and unbuckle harness and retain with buckle tongue holders (p.18). Remove infant insert, lift lower seat cover, and **open rear facing True Tension door** (p.24).

Complete installation using your vehicle's lap/shoulder belt (p.44), the lower anchor belt (p.46), or a compatible vehicle lap belt (p.48).

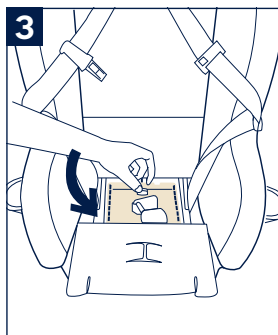
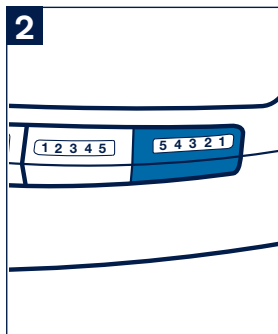

Using Vehicle Lap/Shoulder Belt

(preferred installation method)

- 1 - Route vehicle lap/shoulder belt through **BLUE** rear facing belt path and buckle vehicle lap/shoulder belt. **Vehicle belt must be routed under True Tension door. (1)**

Remove all slack from the vehicle belt system to properly secure this child restraint. **(2)** Lock vehicle belt (refer to vehicle owner's manual).

- 2 - Close True Tension door and replace seat cover and infant insert (if used).

Test by pulling on shoulder belt to ensure it is locked.

To open True Tension door, unbuckle vehicle belt and push down slightly on door to release tension.

⚠ WARNING: Check that child restraint is securely installed before each use.

Check Installation

- Seat is in appropriate rear facing recline position and calf support is extended.
- Seat is securely installed. Hold seat near rear-facing belt path and move seat side to side, front to back, and up and down. Seat should move less than 1 inch.
- Tether strap is not used for rear facing installation and must be secured in storage location on back of child restraint.
- Cup holders may be placed in any position after installation.

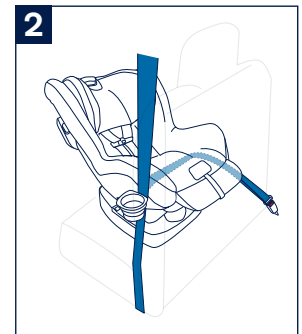
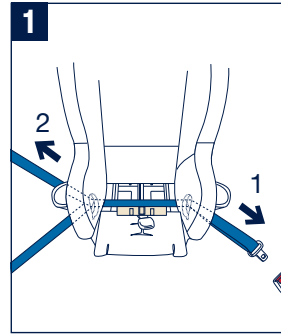

Using Lower Anchor Belt

⚠ WARNING: Do not install by this method for a child weighing more than 35 lb (15.9 kg).

- 1 - Remove lower anchor belt from storage compartment (p.28) and route through **BLUE** rear facing belt path under cup holder.
- 2 - Lengthen lower anchor belt as necessary (p.28) and attach to lower anchor points in vehicle.
- 3 - Remove all slack from lower anchor belt by pulling loop at end of belt.
- 4 - Close True Tension door and replace seat cover and infant insert (if used). Pull crotch belt through slot.

To open True Tension door, unbuckle vehicle belt and push down slightly on door to release tension.

⚠ WARNING: Check that child restraint is securely installed before each use.

Check Installation

- Seat is in appropriate rear facing recline position and calf support is extended.
- Seat is securely installed. Hold seat near rear-facing belt path and move seat side to side, front to back, and up and down. Seat should move less than 1 inch.
- Tether strap is not used for rear facing installation and must be secured in storage location on back of child restraint.
- Cup holders may be placed in any position after installation.

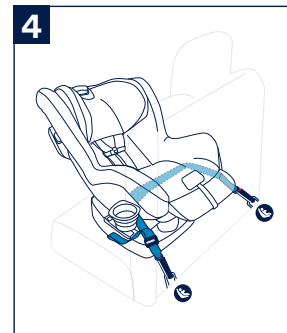
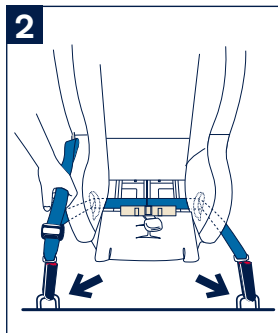
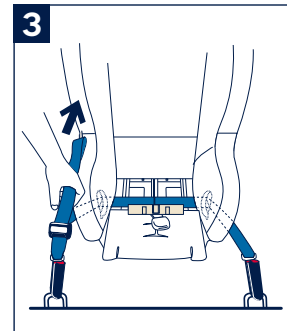
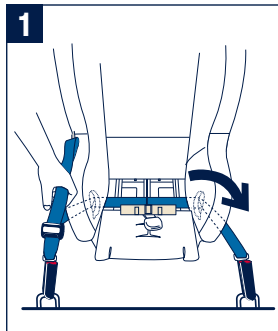

Using Vehicle Lap Belt

1 - Route vehicle lap belt through **BLUE** rear facing belt path and buckle vehicle lap belt. **(1)**

Remove all slack from vehicle lap belt. **(2)**

Lock vehicle belt (refer to vehicle owner's manual).

2 - Close True Tension door and replace seat cover and infant insert (if used).

To open True Tension door, unbuckle vehicle belt and push down slightly on door to release tension.

⚠ WARNING: Check that child restraint is securely installed before each use.

Check Installation

- Seat is in appropriate rear facing recline position and calf support is extended.
- Seat is securely installed. Hold seat near rear-facing belt path and move seat side to side, front to back, and up and down. Seat should move less than 1 inch.
- Tether strap is not used for rear facing installation and must be secured in storage location on back of child restraint.
- Cup holders may be placed in any position after installation.

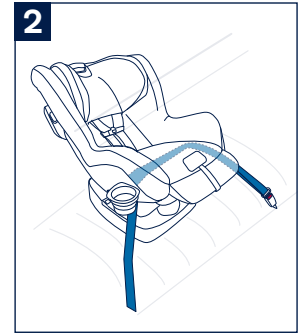
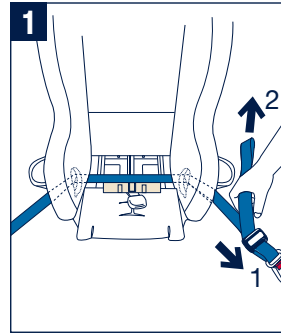

Forward Facing Installation

At least 2 years old, 30–65 lb (13.6–30 kg),
34–49 in. (87–125 cm) or less

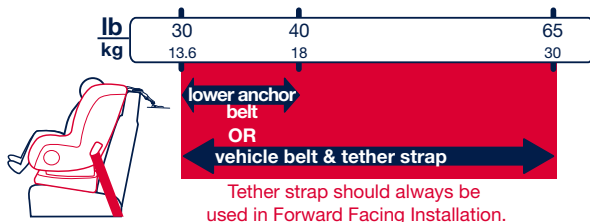

Forward Facing Setup

Remove tether from storage location and lengthen for use (p.36).

- 1 Place child restraint forward facing in a compatible vehicle seat (p.8).
- 2 Select desired forward facing recline position 1–5 (RED) (p.38).
- 3 Fully raise head support. Loosen and unbuckle harness and retain with buckle tongue holders (p.18). Lift seat cover, and **open forward facing True Tension door** (p.24).

Complete installation using your vehicle's lap/shoulder belt (p.52), the lower anchor belt (p.54), or a compatible vehicle lap belt (p.56).

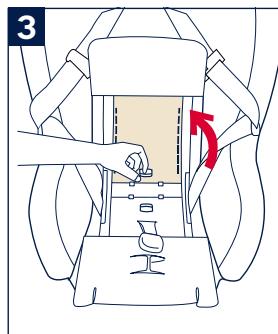
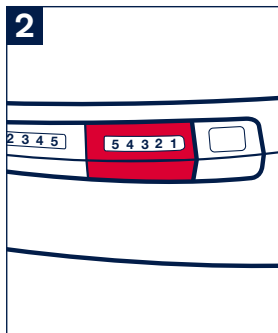
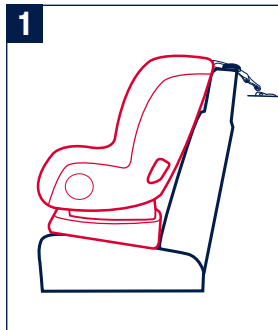

Using Vehicle Lap/Shoulder Belt

(preferred installation method)

- 1 - Route vehicle lap/shoulder belt through **RED** forward facing belt path and buckle vehicle lap/shoulder belt.
- 2 - **Remove all slack** from the vehicle belt system to properly secure this child restraint. **(1)** Lock vehicle belt (refer to vehicle owner's manual).

Close True Tension door and replace seat cover.

Test by pulling on shoulder belt to ensure it is locked.

- 3 - Attach tether hook to tether anchor on vehicle and tighten (p.36).
- 4 - Tuck excess webbing behind child restraint.

To open True Tension door, unbuckle vehicle belt and push down slightly on door to release tension.

⚠ WARNING: Check that child restraint is securely installed before each use.

Check Installation

- Seat is in appropriate forward facing recline position.
- Seat is securely installed. Hold seat near forward facing belt path and move seat side to side, front to back, and up and down. Seat should move less than 1 inch.
- Tether is properly used and attached to vehicle tether anchor.

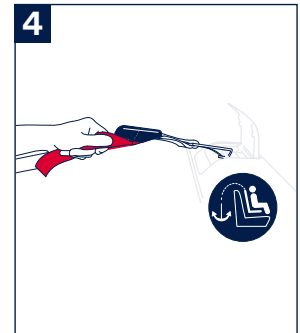
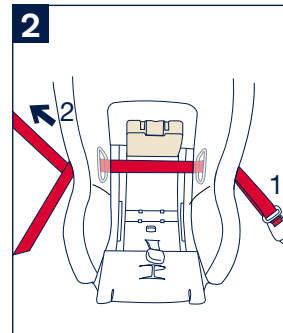
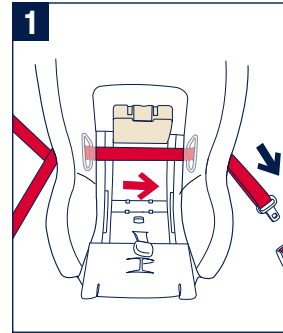

Using Lower Anchor Belt

⚠ WARNING: Do not install by this method for a child weighing more than 40 lb (18 kg).

- 1 - Remove lower anchor belt from storage compartment (p.28) and route through **RED** forward facing belt path.
- 2 - Lengthen lower anchor belt as necessary (p.28) and attach to lower anchor points in vehicle.
- 3 - Remove all slack from lower anchor belt by pulling loop at end of belt straight back from latch connector. Close True Tension door and replace seat cover.
- 4 - Attach tether hook to tether anchor on vehicle and tighten (p.36). Tuck excess webbing behind child restraint.

To open True Tension door, unbuckle vehicle belt and push down slightly on door to release tension.

⚠ WARNING: Check that child restraint is securely installed before each use.

Check Installation

- Seat is in appropriate forward facing recline position.
- Seat is securely installed. Hold seat near forward facing belt path and move seat side to side, front to back, and up and down. Seat should move less than 1 inch.
- Tether is properly used and attached to vehicle tether anchor.

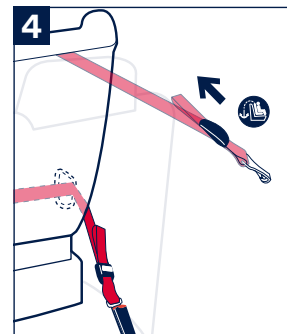
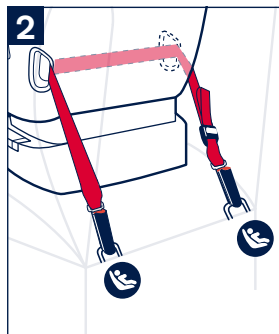
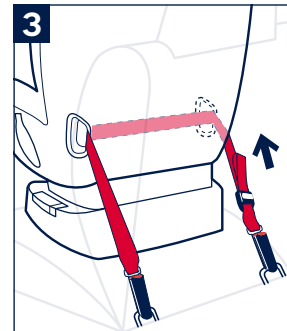
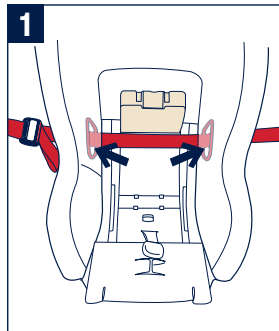

Using Vehicle Lap Belt

- 1 - Route vehicle lap belt through **RED** forward facing belt path and buckle vehicle lap belt.
- 2 - **Remove all slack** from vehicle lap belt. **(1)** Lock vehicle belt (refer to vehicle owner's manual).

Close True Tension door and replace seat cover.

- 3 - Attach tether hook to tether anchor on vehicle and tighten (p.36). Tuck excess webbing behind child restraint.

To open True Tension door, unbuckle vehicle belt and push down slightly on door to release tension.

⚠ WARNING: Check that child restraint is securely installed before each use.

Check Installation

- Seat is in appropriate forward facing recline position.
- Seat is securely installed. Hold seat near forward facing belt path and move seat side to side, front to back, and up and down. Seat should move less than 1 inch.
- Tether is properly used and attached to vehicle tether anchor.

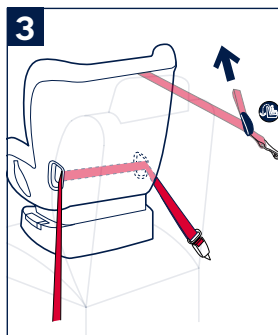
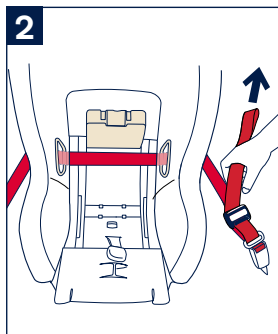
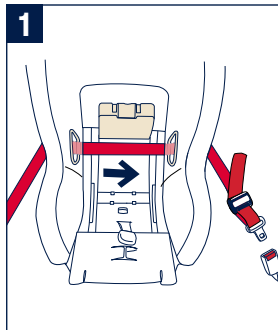

Securing Child in Child Restraint

⚠ WARNING: If your child is not properly secured in the child restraint, they may be ejected in a crash, resulting in serious injury or death.

Loosen and unfasten harness. Retain with buckle tongue holders (p.18).

- 1 - Place child in child restraint with child's back flat against child restraint seat back.
DO NOT allow child to slouch.
- 2 - For **rear facing** use, adjust head support (p.20) to position harness **AT or just below** shoulders.
For **forward facing** use, adjust head support (p.20) to position harness **AT or just above** shoulders.

Bottom of head support should be close to, but not compressing, child's shoulders.

Adjust crotch belt to fit child (p.26). Crotch belt should be close to, but not under child.

Position harness over child's shoulders and around child's waist, and buckle harness.

- 3 - Tighten harness (p.18) to fit snugly on child's shoulders and thighs. It is snug if you cannot pinch a fold in the strap (1).
Fasten and position chest clip (p.18) level with child's armpits (2).

⚠ Pull on shoulder harness to ensure it is secure.

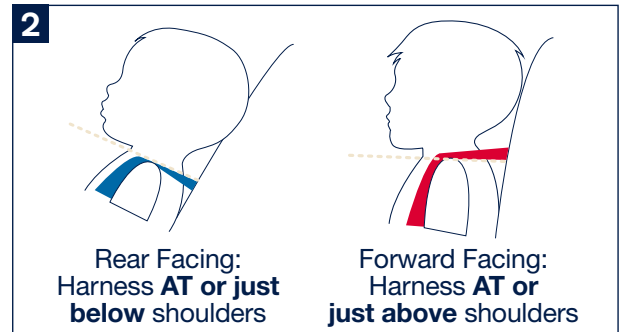
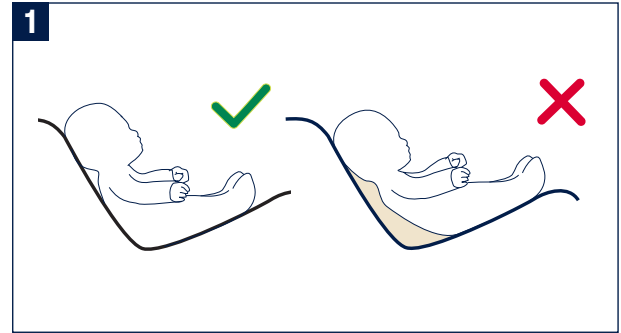

Secure Child Checklist

⚠ WARNING: Before securing child in the restraint, always check that child restraint is properly installed.

- Harness straps are at correct height.
Rear facing: **AT or just below** child's shoulders
Forward facing: **AT or just above** child's shoulders

Use infant insert with infants 5–11 lb (2.3-5 kg) to improve fit to seat and harness and to improve the recline angle for smaller infants.

- Recline angle is appropriate for child.

If infant's head falls forward, child restraint must be reclined more. Use Infant Insert with infants 5–11 lb (2.3–5 kg) to improve the recline angle for smaller infants.

- Head support is locked in one of the 10 positions.
- Harness buckle is securely fastened. Pull to check!
- Harness straps are snug and flat on shoulders and thighs.

A snug strap should not allow any slack. It lies in a relatively straight line without sagging. It does not press on the child's flesh or push the child's body into an unnatural position.

⚠ WARNING: Child cannot be properly secured in child restraint when wearing bulky clothing or wrapped in a blanket. For warmth, add blanket after properly securing child in the child restraint.

- Chest clip is fastened and at child's armpit level.

Aircraft Installation

The FAA recommends that children up to 40 lb (18 kg) use a child restraint while travelling on an aircraft.

This child restraint is certified for use on aircraft. Contact your airline about their policies prior to travel.



Install child restraint rear facing or forward facing in a forward facing aircraft seat following “Using Vehicle Lap Belt” instructions, but install aircraft belt **on top** of closed True Tension door and under seat cover.

Cleaning and Maintenance

⚠ WARNING: Do not attempt to disassemble the child restraint. Only perform steps shown in this manual.

Seat Cover Removal

1 - To remove seat pad:

- a Recline child restraint to rear facing position 1 (BLUE).
- b Set head support in highest position.
- c Loosen and unbuckle harness and chest clip.
- d Fully extend calf support.
- e Remove tether from storage anchor.

Remove harness/buckle pads as well as infant and head inserts.

Take care when removing head support cover so as not to damage the energy absorbing foam.

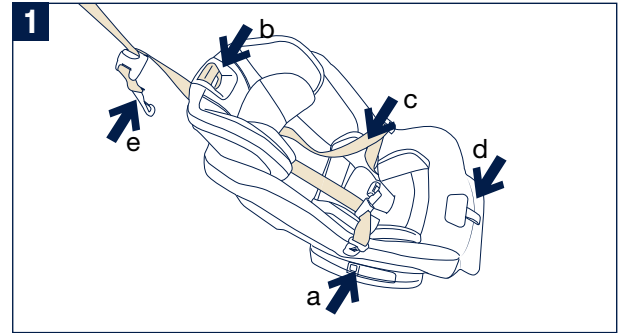

- 1** - Remove head support cover.
 - a** Grasp head support cover at top behind head support button.
 - b** Peel cover off head support; work on one side then the other. Unsnap cover and remove.

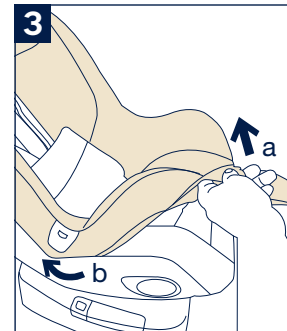
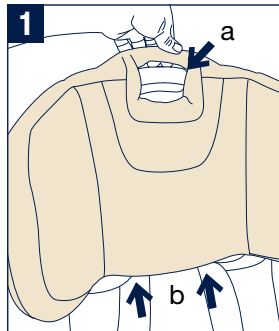

- 2** - Unsnap seat cover.

Remove seat cover from calf support.

- 3** - Remove cover from child restraint.
 - a** Start at bottom, near calf support, work toward buckle holder. Pull seat cover out of seat cover retaining channel.
 - b** Unhook cover beneath buckle tongue holder.
 - c** Continue to the tether.
 - d** Repeat steps A through C for the other side.

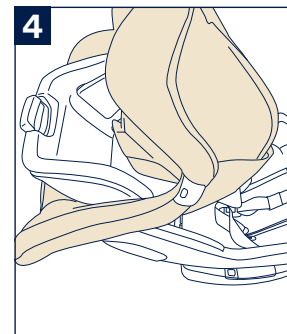
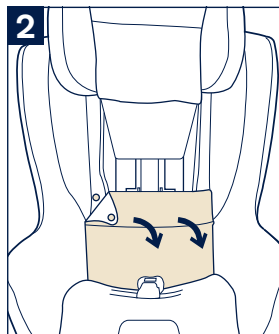

- 4** - Flip cover over the top of the child restraint.

Slide seat cover off of the tether.

Seat Cover Assembly

Reverse steps of seat cover removal.

Recline child restraint to rear facing position 1.

1 - Tuck the seat cover into the retaining channel along the edge of the seat and tuck the corner flap in near the screw.

From the center of the seating area, push the white plastic tab on the seat cover down over the screw

2 - while pulling down on the fabric from the outside.

Ensure both corner pockets are secured to the outside of the calf support.

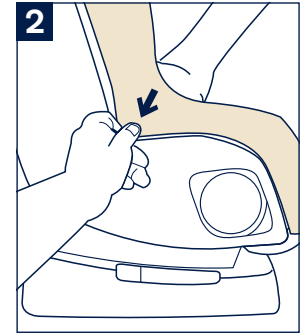
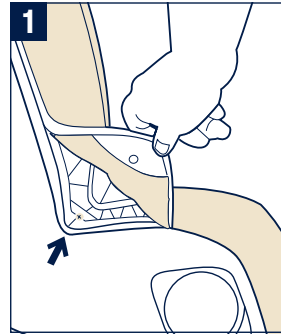

Cleaning the Seat Cover and Harness Pads

When required, seat cover and harness pads may be machine washed with cold water and mild detergent, on the delicate cycle.

Allow to air dry.

DO NOT use bleach or other harsh chemicals to clean your child restraint cover or harness.

DO NOT attempt to iron your child restraint cover.

Cleaning the Infant Insert

When required, the infant insert may be machine washed with a mild soap and cold water. The support wedge located on the back side of the infant insert should be spot cleaned only. **DO NOT** machine wash the support wedge.

Allow to air dry.

Cleaning the Harness

The child restraint harness system cannot be removed. **DO NOT** attempt to remove the harness system.

When required, harness may be hand washed with a sponge and warm soapy water.

Towel dry excess water and allow to air dry.

DO NOT attempt to iron your harness.

Cleaning the Shell

When required, shell may be hand washed with damp sponge.

Towel dry.

DO NOT use abrasive cleansers on the shell.

Cleaning the Buckle

BUCKLE CANNOT BE REMOVED.

To clean buckle, wipe with damp cloth.

Nuna Baby Essentials, Inc. Nuna and all associated logos are trademarks.



Nuna Baby Essentials, Inc.

70 Thousand Oaks Blvd. | Morgantown, PA 19543

1.855.NUNA.USA | nunababy.com