

IMPORTANT!
KEEP THESE
INSTRUCTIONS FOR
FUTURE REFERENCE:
READ CAREFULLY

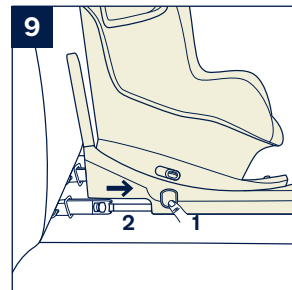

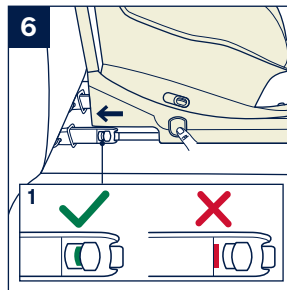

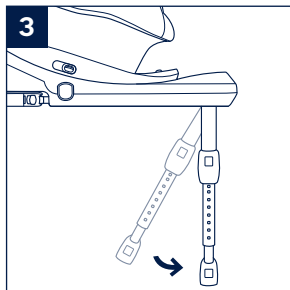

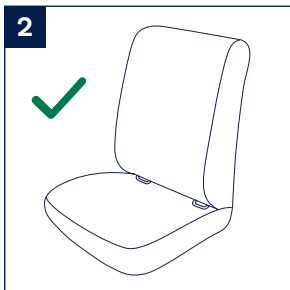
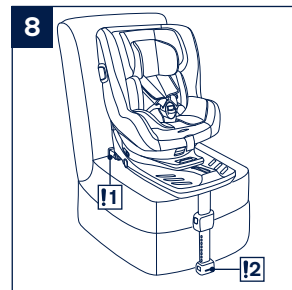
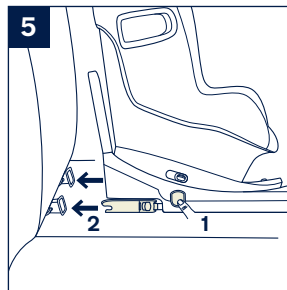
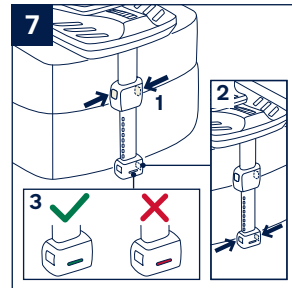
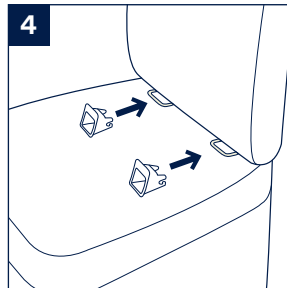
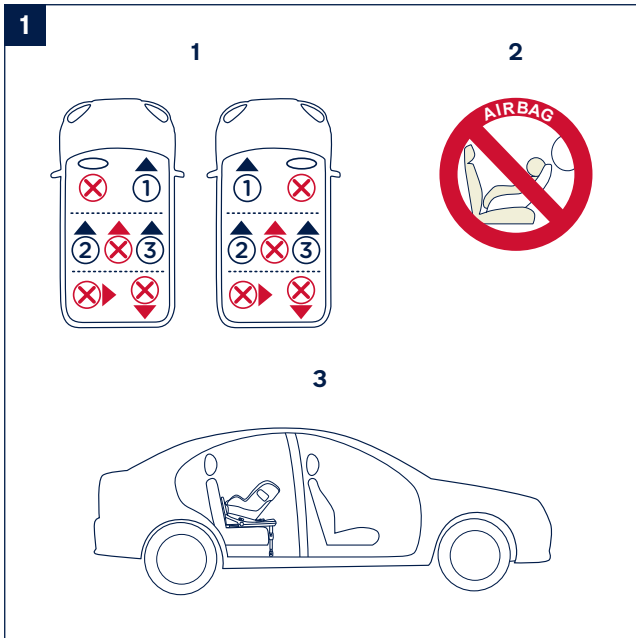
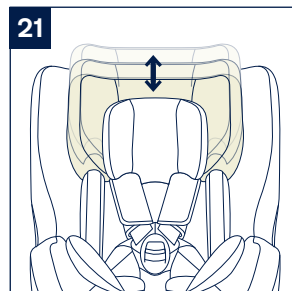
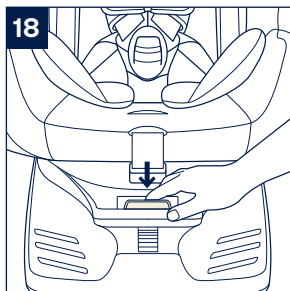
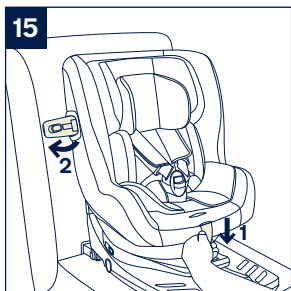
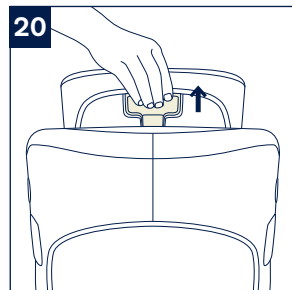
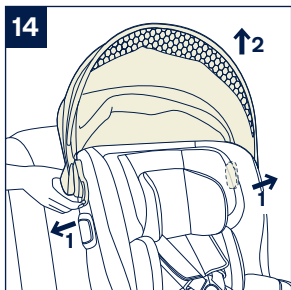
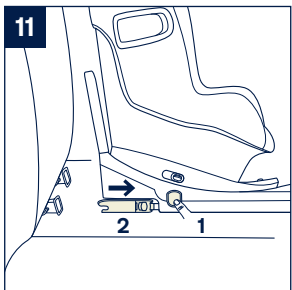
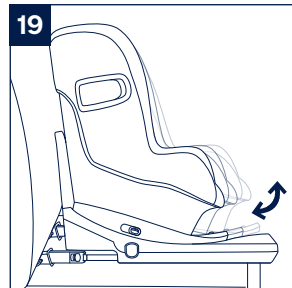
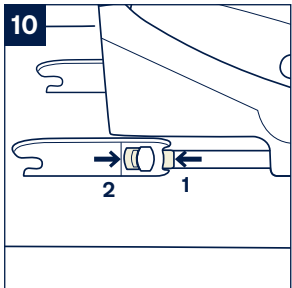
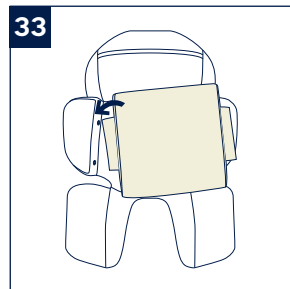
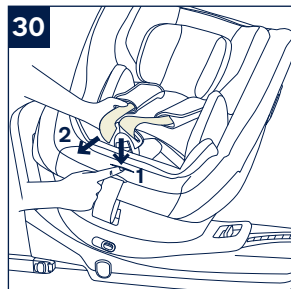
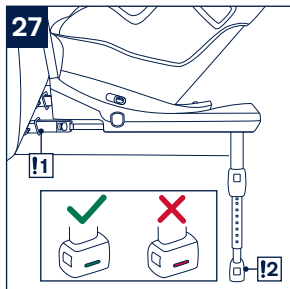
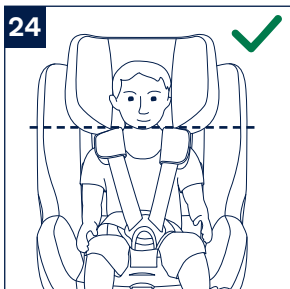
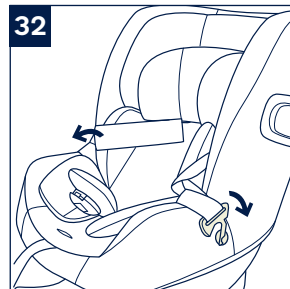
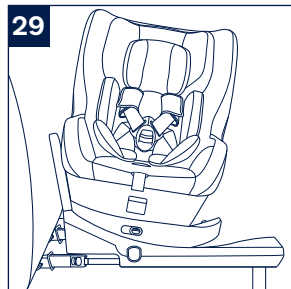
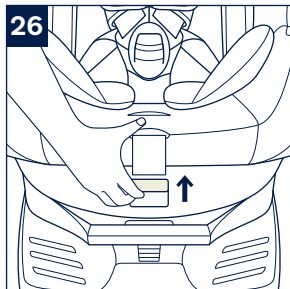
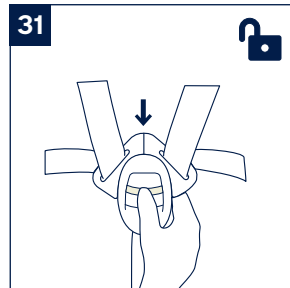
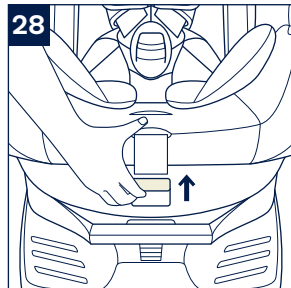
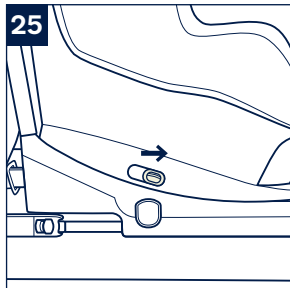
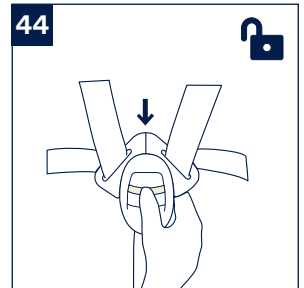
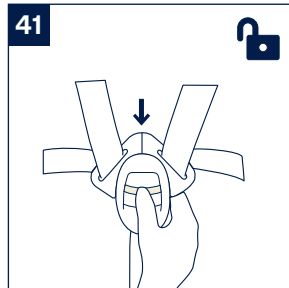
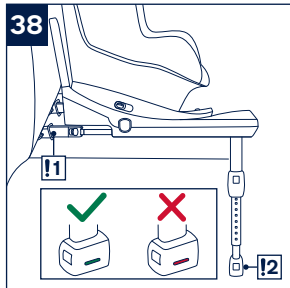
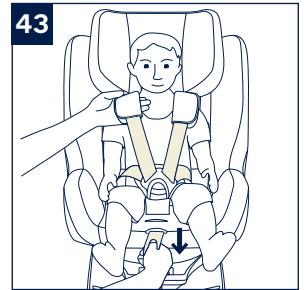
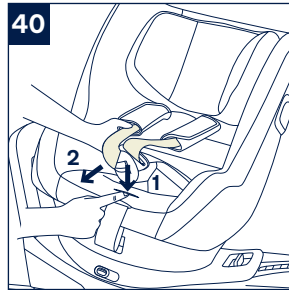
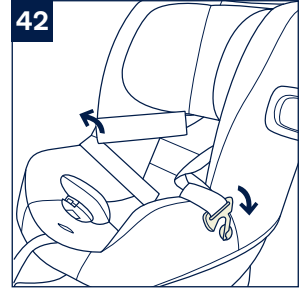
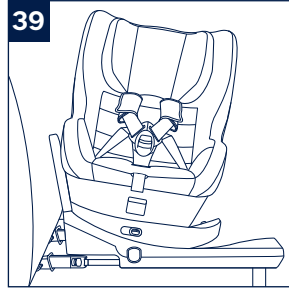
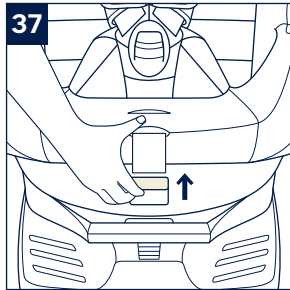
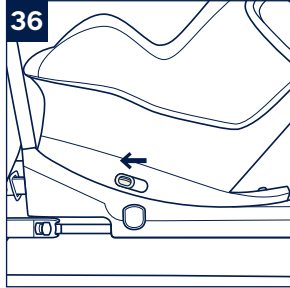
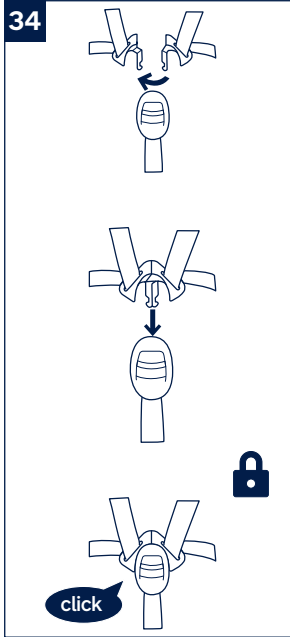

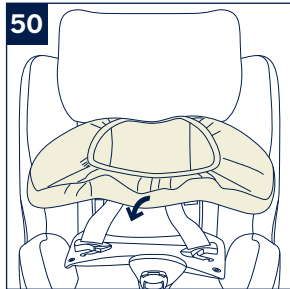
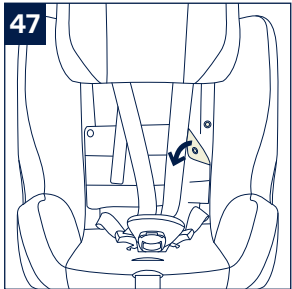
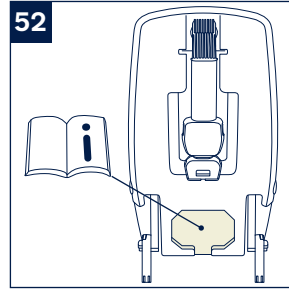
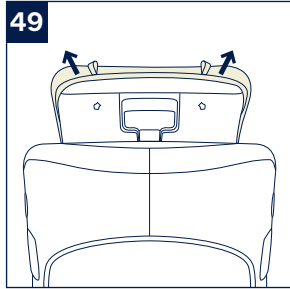
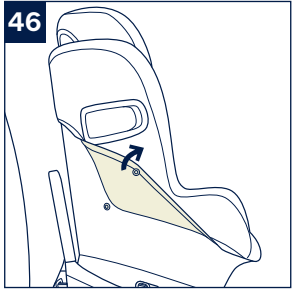
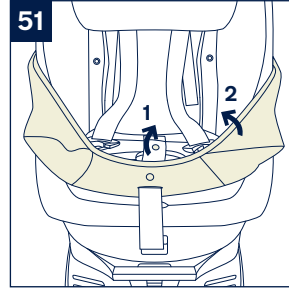
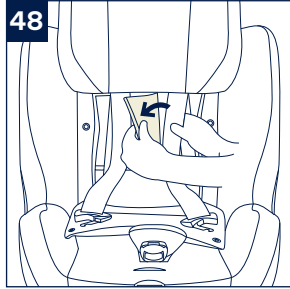
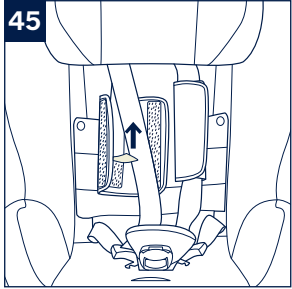

Designed
around your life

Contents

Product information	3
Product Registration	
Warranty	
Child Usage Requirements	4
For Use with Base	5
Parts List	6
Warnings	7
Product Use	10
Cleaning and Maintenance	16
Vehicle Fitting Information	17
繁中	19



Product Information

Model Number: _____

Manufactured in (date): _____

Product Registration

Please fill in the above information. The model number and the manufactured in date are located on the bottom of the PRYM.

To register your product please visit:
<https://nunababy.com/tw/gear-registration>

Warranty



We have purposely designed our high-quality products so that they can grow with both your child and your family. Because we stand by our product, our gear is covered by a custom warranty per product, starting from the day it was purchased. Please have the proof of purchase, model number and manufactured in date available when you contact us.

For warranty information please visit:
www.nunababy.com/tw/warranty

Child Usage Requirements

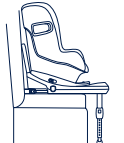
This product is suitable for use with children who meet the following requirements:

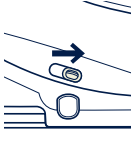
	Installation Mode	Installation	Recline Position
Rearward facing	Child height 40cm-105cm/ Child weight ≤18kg		1-7
Forward facing	Child height 76cm-105cm/ Child weight 9-18 kg		1-7

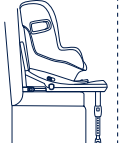
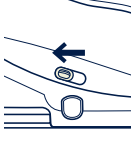
Child's Age	Installation Mode	Installation	Smart Ride™ lock-off
<9kg	Rearward Facing Mode		
>9kg	Rearward/ Forward Facing Mode	 OR 	

For Use with Base

- 1 - The Enhanced Child Restraint with base should be fitted using the ISOFIX connections.
- 2 - This is an “i-Size” Enhanced Child Restraint System. It is for use in i-Size compatible vehicle seating positions as indicated by vehicle manufacturers in the vehicle users’ manual.
- 3 - If in doubt, consult either the Enhanced Child Restraint System manufacturer or the retailer.

Parts List

- | | | | |
|----|------------------------------|----|-------------------------------|
| 1 | Head Support | 12 | Rotating Button |
| 2 | Infant Insert | 13 | ISOFIX Adjustment Button |
| 3 | Seat Pad | 14 | Load Leg Adjustment Button B |
| 4 | Adjustment Webbing | 15 | Side Impact Shield |
| 5 | Recline Adjustment Button | 16 | Head Support Adjustment Lever |
| 6 | Load Leg Adjustment Button A | 17 | Rebound Bar |
| 7 | Load Leg | 18 | Smart Ride™ lock-off |
| 8 | Load Leg Indicator | 19 | ISOFIX Release Button |
| 9 | Shoulder Harness Covers | 20 | ISOFIX Connector |
| 10 | Buckle | 21 | ISOFIX Guides |
| 11 | Harness Adjustment Button | 22 | Canopy |

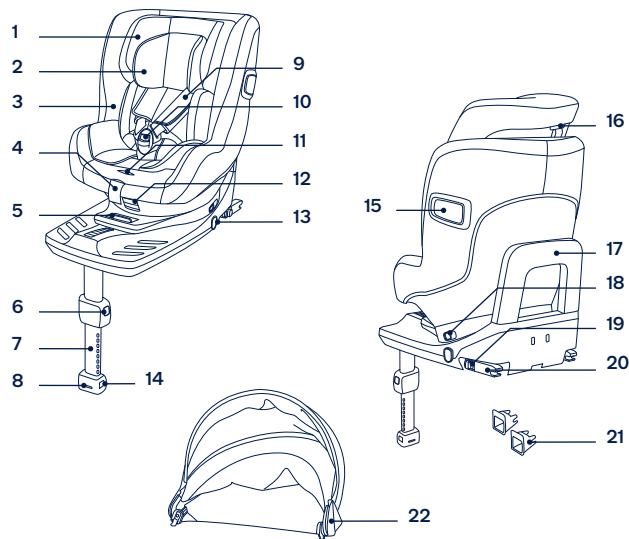

WARNING

Any support-leg should be in contact with the vehicle floor and any straps restraining the child should be adjusted to the child's body. The straps should not be twisted.

After your child is placed in this enhanced child restraint, the child harness must be used correctly. Ensure that any lap strap is worn low down, so that the pelvis is firmly engaged, shall be stressed.

Any luggage or other objects liable to cause injuries in the event of a collision shall be properly secured.

Always secure child in enhanced child restraint, even on short trips, as this is when most accidents occur.

Concern the danger of making any alterations or additions to the device without the approval of the competent authority, and a danger of not following closely the installation instructions provided by the enhanced child restraint manufacturer.

Children are not left in their enhanced child restraint system unattended.

Consult the distributor for issues concerning maintenance, repair and part replacement.

Do take care so that the rigid items and plastic parts of a enhanced child restraint shall be so located and installed that they are not liable to become trapped by a moveable seat or in a door of the vehicle.

Frequently check the ISOFIX guides for dirt and clean them if necessary. Reliability can be effected by ingress of dirt, dust, food particles etc.

Please keep this enhanced child restraint away from sunlight, because it may be too hot for child's skin. Always touch the enhanced child restraint before placing child in it.

Please check before you purchase this enhanced child restraint to make sure it can be installed properly in your vehicle.

Remove this enhanced child restraint from the vehicle seat when it is not in use for a long period of time.

To use this enhanced child restraint with the ISOFIX connections your child must meet the following requirements.

Rearward Facing:

Child height 40cm-105cm/ Child weight ≤ 18kg;

Forward Facing:

Child height 76cm-105cm/ Child weight 9-18kg;

This enhanced child restraint should be replaced when it has been subject to violent stresses in an accident. An accident can cause damage to it that you cannot see.

The enhanced child restraint system shall not be used without the soft goods.

The soft goods should not be replaced with any other than the one recommended by the manufacturer, because the soft goods constitutes an integral part of the restraint performance.

The instructions should be retained on the enhanced child restraint for its life period or in the vehicle handbook in the case of built-in restraints. The user shall also be referred to the vehicle manufacturer's handbook.

The parts of this enhanced child restraint should not be lubricated in any way.

IMPORTANT - DO NOT USE FORWARD FACING BEFORE THE CHILD'S AGE EXCEEDS 2 years (Refer to instructions).

NO enhanced child restraint can guarantee full protection from injury in an accident. However, proper use of this enhanced child restraint will reduce the risk of serious injury or death to your child.

DO NOT use this enhanced child restraint if it has damaged or missing parts.

DO NOT have your child in large/oversized clothes because this may prevent your child from being properly and securely fastened by the shoulder harness straps and the crotch strap between the legs.

DO NOT leave this enhanced child restraint or other items unbelted or unsecured in your vehicle because an unsecured enhanced child restraint can be thrown around and may injure occupants in a sharp turn, sudden stop, or collision.

DO NOT use the rearward facing enhanced child restraint systems in seating positions where there is an active frontal airbag installed. Death or serious injury may occur.

DO NOT put anything other than the recommended inner cushions in this enhanced child restraint.

NEVER use a second-hand enhanced child restraint or an enhanced child restraint whose history you do not know because it may have structural damage that compromises your child's safety.

NEVER use ropes or any other substitutes to secure enhanced child restraint in vehicle or to secure child into enhanced child restraint.

The child restraint may not fit in all approved vehicles when used in one of these positions.

Product Use

DO NOT install this enhanced child restraint on vehicle seats that face sideways or rearward with respect to the moving direction of the vehicle. **(1)-1**

DO NOT use the rearward facing enhanced child restraint systems in seating positions where there is an active frontal airbag installed. Death or serious injury may occur. **(1)-2** Please reference vehicle owner's manual for more information.

It is recommended to install this enhanced child restraint on the rear vehicle seat. **(1)-3**

This enhanced child restraint is suitable for vehicle seats with i-Size ISOFIX anchor points. **(2)**

DO NOT install this enhanced child restraint on vehicle seats unstable during installation.

Installation

- 1** - After placing the base on the vehicle seat, pull the load leg downward to floor. **(3)**
- 2** - Fit the ISOFIX guides into the ISOFIX anchor points. **(4)** The ISOFIX guides can protect the surface of the vehicle seat from being torn. They will also guide the ISOFIX connectors.
- 3** - Press the ISOFIX adjustment button on either side of the base, then pull out the ISOFIX connectors. **(5)**

! Make sure that both ISOFIX connectors are securely attached to their ISOFIX anchor points.

There should be two audible clicks and the colors of the indicators on the both ISOFIX connectors should be completely green. **(6)-1**

! After successfully installing the ISOFIX connectors, press the ISOFIX adjustment buttons again while pushing the seat back until it comes in contact with the vehicle seat back. **(6)**

Check to make sure the enhanced child restraint is securely installed by pulling on the both ISOFIX connectors.

- 4** - There are 9 adjustable positions for ISOFIX. Press the ISOFIX adjustment buttons and push the base back against the vehicle seat until tight.
- 5** - After placing the enhanced child restraint on the vehicle seat, extend the load leg to floor. **(7)** The load leg indicator will show green when installed correctly, red means it is installed incorrectly. **(7)-3**

The load leg has multiple adjustable positions. When the load leg indicator shows red this means the load leg is in the wrong position.

- ! Make sure the load leg is secure by pressing down on the front of the enhanced child restraint.
 - ! To shorten the load leg, squeeze the load leg release button and pull the load leg upwards.
- 6 - The completely assembled enhanced child restraint is shown as (8).
 - ! Check to make sure the base is securely installed by pulling on both ISOFIX connectors.
 - ! The ISOFIX connectors must be attached and locked onto the ISOFIX anchor points. (8)-1
 - ! The load leg must be installed correctly with green indicator. (8)-2
 - 7 - To remove the enhanced child restraint, press the ISOFIX adjustment buttons (9)-1 and pull the base away from the seat. (9)-2
 - 8 - Then while squeezing the ISOFIX release button and secondary lock on the ISOFIX connectors remove from the vehicle. (10)

- 9 - Press the ISOFIX adjustment buttons to store the ISOFIX. (11)

Assemble Canopy

- 1 - Push canopy pivot into the canopy mount to assemble canopy. (12)
- 2 - The canopy can be opened or folded, pull it toward front or back. (13)
- 3 - To remove canopy, pull the snap finger (14)-1, and pull out canopy pivot. (14)-2

Use Side Impact Shield

- ! Ensure the side impact shield is locked in the open position for maximum side impact safety.
- 1 - Side impact shields are automatically activated when the harness buckle is moved back into position and the harness is tightened, both sides will be opened automatically. (15)
 - ! **IMPORTANT:** Please note that unfolding the side impact protection elements do NOT mean that the child is already restrained tight enough.

- 2 - The side impact shield opposite the vehicle door can be closed to allow more seating space, if needed. The side closest to the vehicle exterior should always be in the open position. (16)

- 3 - The side impact shield can be manually opened as shown on (17).

Recline Adjustment

Squeeze the recline adjustment button (18) to adjust the enhanced child restraint to the proper position. The recline angles are shown as (19).

Please recheck the load leg position after reclining.

There are 7 recline angles for baby mode and 7 positions for toddler mode.

Height Adjustment for Head Support and Shoulder Harnesses

Check that shoulder harness straps are set at the proper height.

Squeeze the head support adjustment lever (20) while pulling up or down on the head support until it snaps into one of the 8 positions. The head support positions are shown as (21).

- ! When used rearward facing, the shoulder harness height must be even with or below the top of child's shoulders. (22)(23)
- ! When used forward facing, the shoulder harness height must be even with the top of child's shoulders. (24)

Rearward Facing Mode

Rearward Facing

Child height 40cm-105cm/ Child weight ≤18kg

Recline position

Position 1-7

- 1 - Please slide Smart Ride™ lock-off to right when enhanced child restraint used in rearward facing mode. (25)
- 2 - Press the rotating button to rotate the seat to the rearward facing position. (26)(27)
- ! The ISOFIX connectors must be attached and locked onto the ISOFIX anchor points. (27)-1
- ! The load leg must be installed correctly with green indicator. (27)-2

Securing Child

After the child is placed into the seat, check whether the shoulder harness straps are at proper height.

- 1 - Press the rotating button to rotate for easier side loading/unloading of the child. (28)(29)
- 2 - Press the harness adjustment button, while pulling out the shoulder harnesses to the desired (Pull from below the fixed shoulder pads to lengthen) length. (30)
- 3 - Unlock the buckle of the harnesses by pressing the red button. (31)
- 4 - Fix the buckles on the both sides of the seat which located on the both sides of seat to make placing the child in rearward facing mode more convenient. (32)
- 5 - Please make sure the infant insert has the wedge assembled before using it for infant. (33)

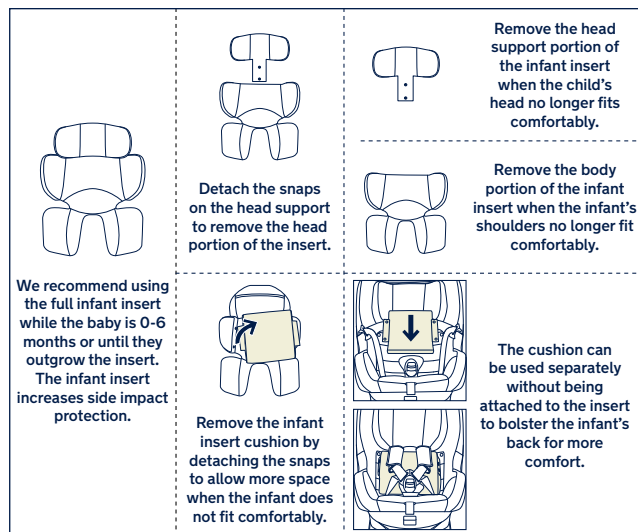

- 6 - Place the child into the enhanced child restraint and lock the buckle. Please refer to (34).
- 7 - Tighten the shoulder harness straps by pulling the adjustment webbing. (35)
 - ! Make sure the space between the child and the shoulder harness straps is about the thickness of one hand.

Forward Facing Mode

Forward Facing

Child height 76cm-105cm/ Child weight 9-18kg

Recline position

Position 1-7

- ! NOT allowed to use forward facing before the age of 2 years.
- 1 - Please slide Smart Ride™ lock-off to left when enhanced child restraint used in forward facing mode. (36)
 - 2 - Press the rotating button to rotate the seat to the forward facing position. (37)(38)
 - ! The ISOFIX connectors must be attached and locked onto the ISOFIX anchor points. (38)-1
 - ! The load leg must be installed correctly with green indicator. (38)-2

Securing Child

After the child is placed into the seat, check whether the shoulder harness straps are at proper height.

- 1 - Press the rotating button to rotate for easier side loading/unloading of the child. (39)
- 2 - Press the harness adjustment button, while pulling out the shoulder harnesses to the desired (Pull from below the fixed shoulder pads to lengthen) length. (40)
- 3 - Unlock the buckle of the harnesses by pressing the red button. (41)
- 4 - Fix the buckles on the both sides of the seat which located on the both sides of seat to make placing the child in forward facing mode more convenient. (42)
- 5 - When installing the enhanced child restraint in the forward facing mode, do not use the infant insert.

- 6 - Place the child into the enhanced child restraint and pass both arms through the harnesses. Engage the buckle. Please refer to (34).
- 7 - Tighten the shoulder harness straps by pulling the adjustment webbing. (43)
 - ! Make sure the space between the child and the shoulder harness straps is about the thickness of one hand.

Detach Soft Goods

- 1 - Open the buckle (44), then remove the infant insert.
- 2 - Detach the hook and loop fasteners to remove the shoulder harnesses cover. (45)
- 3 - Open the snaps. (46)
- 4 - Open the snaps on the main seat pad behind shoulder harnesses. (47)
- 5 - Move the shoulder harness straps behind the flap below the headrest. (48)
- 6 - Unfasten the elastic on the top of headrest and then remove the head support soft goods. (49)(50)
- 7 - Open the velcro on the main seat pad and adjustment webbing (51)-1, then remove the soft goods. (51)-2

To assemble soft goods according to reversed steps above.

Please keep the instruction manual in the storage compartment at the bottom of the enhanced child restraint. (52)

Cleaning and Maintenance

After removing the wedge from the insert, please store it somewhere that the child cannot access it.

Please wash the bottom seat pad and the top seat cover with cold water under 30°C.

Do not iron the soft goods.

Do not bleach or dry clean the soft goods.

Do not use undiluted detergents, gasoline or other organic solvents to wash the enhanced child restraint. It may cause damage to the product.

Use only mild detergent, water and a soft cloth to clean the enhanced child restraint shell, and harness straps.

Do not twist the soft goods to dry with great force. It may leave the soft goods with wrinkles.

Please hang dry the soft goods in the shade.

Please remove the enhanced child restraint from the vehicle seat if not in use for a long period of time. Put the enhanced child restraint in a cool, dry place and somewhere your child can not access it.

Vehicle Fitting Information

The child restraint with base is classified for “Semi-Universal” or ISOFIX child restraint system use. It is suitable for fixing into the seat positions of most cars. The letters on the diagram below correspond with the vehicle fitting positions listed in the following pages.

Seat positions in other cars may also be suitable to accept the child restraint. If in doubt, consult either the child restraint manufacturer or the distributor.

DO NOT install this child restraint on the front vehicle seats.

DO NOT use the rearward facing enhanced child restraint systems in seating positions where there is an active frontal airbag installed. Death or serious injury may occur.

- Your child restraint can be fitted
- ✗ Your child restraint can not be fitted
- ⚡ Electric or hybrid vehicles
-  i-Size vehicles

SB! Vehicles with under floor storage boxes.

If your vehicle is not listed in this manual or it is not marked with either a • or ✗ then please refer to your vehicle's handbook or contact the manufacturer for further information.

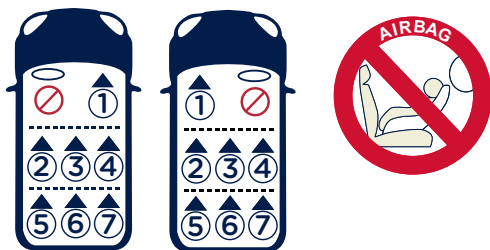

請妥善保存本說明書 以備不時之需!

使用產品前請仔細閱讀本說明書，
並妥善保存以供日後參照。不依照本說明書的指示
操作，可能會影響到您兒童的安全。

目錄

產品資訊	21
保固與售後服務	
保固條件	
兒童使用要求	22
產品資訊	23
產品組件及各部件名稱	24
警告	25
安裝注意事項	27
維修與保養	32
汽車安裝資訊	33

產品資訊

產品名稱: _____

生產日期: _____

保固與售後服務

產品於保固期間內發生問題，請與零售商聯絡；若零售商無法提供服務，他們會聯絡當地的Nuna經銷商。請留意產品底部的產品型號與生產日期序號。當有保固需求時，請提供以上產品資訊。

請至 nunababy.com/tw/gear-registration 網站登記您購買的產品。

保固條件

保固始於產品購買日，我們提供維修服務，但不提供產品退換。保固期限不會因零件更換或維修而延長。

Nuna有權利針對產品進行改善設計，此前製造的產品則無更換義務。相關保固資訊，詳見官網：



www.nunababy.com/tw/warranty

品名	汽車用兒童保護裝置
型號	PRYM、CS05513、CS05514
質量等級	O+級、I級
適用範圍	新生兒-18公斤(0-4歲)的兒童
主要材質	塑膠、五金、布
原產地	中國

兒童使用要求

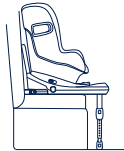
本產品適合於滿足下列要求的兒童:

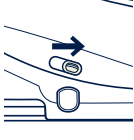
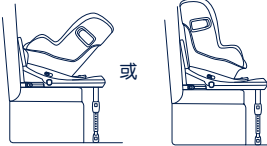
	安裝模式	安裝圖示	座椅段位
後向安裝模式	未滿18kg		1-7
前向安裝模式	9-18kg		1-7

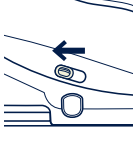
兒童體重	安裝模式	安裝圖示	前向乘坐防誤用按鈕
<9kg	後向安裝模式		
>9kg	前向安裝模式	 或 	

產品資訊

- 1- 此兒童保護裝置被歸類為“半通用型”，適用安裝在大部分(並非全部)之車輛座椅位置。
- 2- 其他車輛型式亦有可能適用此兒童保護裝置。若有疑問，請洽兒童保護裝置製造商或進口商。

用ISOFIX固定裝置安裝

- 1- 此為ISOFIX兒童保護裝置。符合安全標準CNS 11497。用於裝有ISOFIX固定器系統之車輛座椅。
- 2- 它安裝適用於車輛配有經認可之ISOFIX安裝位置。(請參照車輛使用手冊)請依此兒童保護裝置之種類及ISOFIX尺寸等級，安裝於附有ISOFIX固定器之車輛座椅上。
- 3- ISOFIX尺寸等級為A、D。

產品組件及各部件名稱

- | | |
|------------|---------------|
| 1 頭靠 | 12 座椅旋轉按鈕 |
| 2 小座墊 | 13 ISOFIX收合按鈕 |
| 3 座墊 | 14 支撐腳調整按鈕B |
| 4 調整織帶 | 15 側向保護塑膠 |
| 5 背靠調整按鈕 | 16 頭靠調整手把 |
| 6 支撐腳調整按鈕A | 17 頂杆 |
| 7 支撐腳 | 18 前向乘坐防誤用按鈕 |
| 8 支撐腳指示器 | 19 ISOFIX釋鎖按鈕 |
| 9 肩帶護片 | 20 ISOFIX連接器 |
| 10 安全扣 | 21 ISOFIX導向器 |
| 11 織帶調整按鈕 | 22 遮陽篷 |

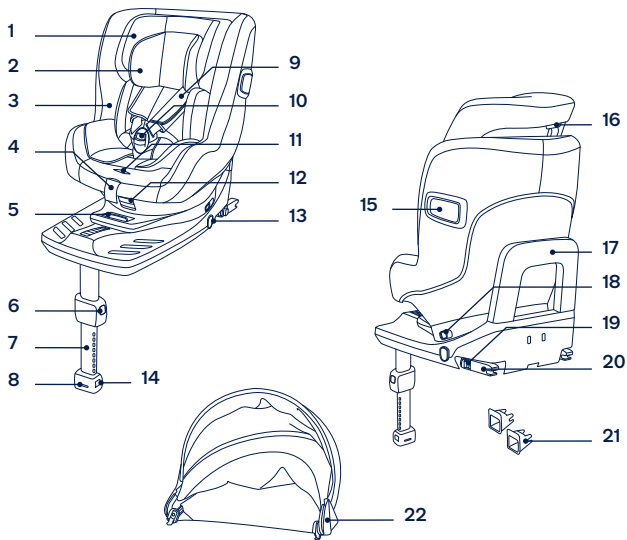

⚠ 警告

沒有任何兒童保護裝置可以保證100%遠離傷亡，然而正確使用兒童保護裝置可以降低兒童傷亡的機率。

本兒童保護裝置適用於體重18kg(約4歲)以下的兒童。

前向安裝勿提供2歲以下兒童乘坐，超過2歲兒童，仍宜儘量使用後向安裝。

任何束縛兒童之織帶應根據兒童身體進行調整，且此織帶不應扭曲。

將兒童放在本兒童保護裝置後，必須正確的扣合及使用兒童保護裝置安全帶，並確保腰部織帶佩戴時能有效束縛骨盆部位。

本兒童保護裝置若於意外中遭受劇烈撞擊後，不可繼續使用，應立即更換兒童保護裝置。意外可能導致兒童保護裝置產生潛在危險。

請勿擅自改造本兒童保護裝置，或使用其他廠商生產的零件來配合本兒童保護裝置使用，會對兒童造成危險。沒有認證許可的產品和經過改裝的產品是危險的，並且附近沒有製造商提供的安裝說明也是很危險的。

請讓兒童保護裝置遠離日光，以免產品溫度過高對兒童的皮膚造成傷害。

在無人照料下，不得讓兒童留在兒童保護裝置內。

任何行李或其他可能在碰撞中造成傷害之物品應適當牢固。

兒童保護裝置不得於未附表面座布下使用，且表面座布為兒童保護裝置束縛性能之整體構成要件，故表面座布不得以非兒童保護裝置製造商建議之物品取代。

不可使用除使用說明書中所標註以外之其他受力點。

請勿在未閱讀或了解本兒童保護裝置說明書及汽車說明書之前，使用或安裝本兒童保護裝置。因為可能會導致嚴重受傷或死亡的危險。

本兒童保護裝置如有任何損壞或零件缺失時，請勿繼續使用。

請勿讓您的兒童穿着過大的衣物，所穿的衣物必須能讓兒童保護裝置的安全帶適當而安全地扣在兒童兩腿之間。

請勿將本兒童保護裝置安裝在汽車前座上。

切勿將後向兒童保護裝置裝置於有空氣囊之前排座椅位置，防止發生死亡或嚴重傷害。

請勿使用二手或來歷不明的兒童保護裝置，因為它們可能會有危害兒童安全的潛在危險。

請勿把本兒童保護裝置當作平常的椅子使用，會容易翻倒造成傷害。

請勿在兒童保護裝置內放置其他內墊物品。

請勿讓汽車車門卡住兒童保護裝置的任何組件。

長期不使用兒童保護裝置時，請將其搬離汽車座椅。

使用本產品前，請取掉PE袋和包裝材料，並放到嬰兒和兒童觸摸不到的地方。

有關零件更換或維修問題，請向進口商諮詢。

請勿將任何物品置於支撐腳附近。

請勿搬運乘坐着兒童的兒童保護裝置。

請時常查看ISOFIX導向器是否有髒污，必要時請清洗導向器。髒污、灰塵、食物殘渣等會影響產品安裝的穩定性。

請勿將未使用ISOFIX固定住的兒童保護裝置留在車內，以免緊急剎車時，傷害到其他乘客。若不經常使用兒童保護裝置時，請將其搬離汽車座椅。

以下汽車座椅不能安裝本兒童保護裝置：

- 1- 二點式或三點式安全帶的汽車座椅。
- 2- 相對於汽車的行駛方向，橫向或後向的汽車座椅。
- 3- 安裝時不穩定的汽車座椅。

必須使用頂杆。

安裝注意事項

請勿將此兒童保護裝置安裝在相對於汽車的行駛方向橫向或後向的汽車座椅上(1)-1

切勿將後向兒童保護裝置裝置於有空氣囊之前排座椅位置，防止發生死亡或嚴重傷害(1)-2

必須將此兒童保護裝置安裝於汽車後座(1)-3

此兒童保護裝置適合安裝在設置有ISOFIX固定裝置的汽車座椅上(2)

請勿將此兒童保護裝置安裝於可移動的汽車座椅上。

安裝底座

1- 展開底座支撐腳(3)

2- 將ISOFIX導向器固定到ISOFIX固定點上(4)，ISOFIX導向器既可防止汽車座椅表面被刮破，又可為ISOFIX連接器安裝導向。

3- 按壓底座的ISOFIX收合按鈕，拉出ISOFIX連接器(5)

4- 將ISOFIX連接器與ISOFIX導向器對齊後，將ISOFIX連接器連接到ISOFIX固定點上(6)

！請確定左右兩邊的ISOFIX連接器都已固定到ISOFIX固定點上，且聽到兩次“咔嚓”聲和兩個ISOFIX連接器上的指示器應顯示綠色(6)-1

！同時往外拉兩邊的ISOFIX連接器，以確保ISOFIX連接器已固定。

5- ISOFIX有9個段位可調。按壓ISOFIX收合按鈕，移動兒童保護裝置，確保兒童保護裝置與汽車座椅背靠緊貼。

6- 將兒童保護裝置置於合適的汽車座椅，將支撐腳延伸到地面(7)。支撐腳正確安裝時，支撐腳指示器顯示綠色，否則顯示紅色(7)-3

支撐腳有多個調整段位，支撐腳指示器顯示紅色時，表示支撐腳處於錯誤段位，請重新操作至正確位置為止。

！請確保支撐腳與汽車地面完全接觸。

！按壓支撐腳釋鎖按鈕可將支撐腳向上調整。

7- 兒童保護裝置安裝完成如(8)所示。

！請確保底座兩邊的ISOFIX連接器都已固定到ISOFIX固定點上(8)-1

！請確保支撐腳與汽車地面完全接觸。且支撐腳指示器顯示綠色(8)-2

8- 移除兒童保護裝置時，按壓ISOFIX收合按鈕(9)-1，將兒童保護裝置與汽車座椅背靠分離，再按壓兩側的ISOFIX連接器上的第二道安全鎖與釋鎖按鈕，同時將兒童保護裝置往外拉即可(10)

9- 按壓ISOFIX收合按鈕收合ISOFIX連接器(11)

安裝遮陽篷

1- 將遮陽篷旋轉座固定於遮陽篷固定座上(12)

2- 打開遮陽篷，請將遮陽篷推向前方。折疊遮陽篷，請將遮陽篷拉向後方(13)

3- 打開遮陽篷彈性手指扣，拆下遮陽篷(14)

使用側向保護塑膠

1- 當安全扣正確扣合後，拉緊調整織帶，兩側的側向保護塑膠會自動展開(15)

！重要：請注意側向保護塑膠展開並不表示兒童已被正確束縛。

！必須打開側向保護塑膠才能更好的保護兒童的安全。

2- 如果汽車座椅乘車空間不足時，可將靠近內側的側向保護塑膠關閉。靠近外側的側向保護塑膠處於打開狀態(16)

3- 側向保護塑膠可以手動打開(17)

座椅背靠角度調整

按壓座椅背靠調整按鈕(18)，即可滑動兒童保護裝置本體，並將兒童保護裝置角度調至適當位置，角度調整後如(19)所示。

！請在座椅調整後再次檢查支撐腳是否正確安裝。

後向使用和前向使用的背靠角度調整都有7個段位。

頭靠與肩帶高度調整

檢查肩帶是否在適當位置。

按壓頭靠調整手把(20)，同時上下滑動頭靠到合適高度，頭靠高度共有8個段位，調整如(21)所示。

！使用後向模式時，肩帶高度需與兒童肩膀相同或略低於兒童的肩膀而不能高於兒童的肩膀(22)(23)

！使用前向模式時，肩帶高度需與兒童的肩膀相同(24)

後向使用

未滿18kg/0-4歲的兒童

參考年齡 新生兒 - 4歲

座椅段位 1 - 7段

- 1- 後向使用時，請將前向乘坐防誤用按鈕向右邊滑動(25)
- 2- 按壓座椅旋轉按鈕，將兒童保護裝置面向汽車座椅(26)(27)

！ISOFIX連接器須鎖定在ISOFIX固定點上(27)-1

！底座支撐腳須正確固定，並以綠色顯示(27)-2

兒童乘坐

將兒童放入兒童保護裝置後，請確認肩帶高度是否調整在適當位置。

- 1- 按壓座椅旋轉按鈕可以旋轉本體方便兒童從側面進出(28)(29)
- 2- 按壓織帶調整按鈕，同時將肩帶(從肩帶護片下方)拉出至適當長度(30)
- 3- 按壓紅色按鈕，鬆開安全扣(31)
- 4- 將安全帶扣具固定在座椅兩側方便放置兒童(32)
- 5- 在使用小座墊之前請將支撐塊安裝在小座墊上(33)

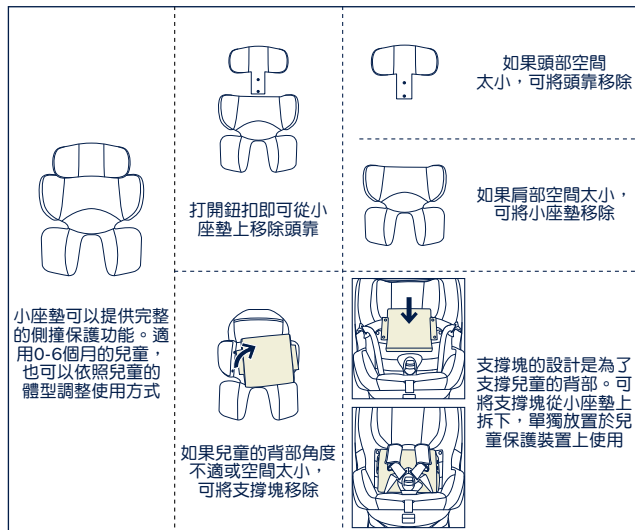

6- 將兒童放入兒童保護裝置內並扣好安全扣(34)

7- 下拉調整織帶，調整肩帶至適當長度，以配合兒童身形(35)

！確保兒童與肩帶之間須可以放進一個手掌的厚度。

前向使用

9-18kg/2-4歲的兒童

參考年齡 2 - 4歲

座椅段位 1 - 7段

- 1- 前向使用時，請將前向乘坐防誤用按鈕向左邊滑動(36)
- 2- 按壓座椅旋轉按鈕，將兒童保護裝置面向汽車行駛方向(37)(38)

！ ISOFIX連接器須鎖定在ISOFIX固定點上(38)-1

！ 底座支撐腳須正確固定，並以綠色顯示(38)-2

兒童乘坐

將兒童放入兒童保護裝置後，請確認肩帶高度是否調整在適當位置。

- 1- 按壓座椅旋轉按鈕可以旋轉本體方便兒童從側面進出(39)
- 2- 按壓織帶調整按鈕，同時將肩帶(從肩帶護片下方)拉出至適當長度(40)
- 3- 按壓紅色按鈕，鬆開安全扣(41)
- 4- 將安全帶扣具固定在座椅兩側方便放置兒童(42)
- 5- 前向使用時請勿使用小座墊。
- 6- 將兒童放入兒童保護裝置內並參照(34)扣好安全扣。
- 7- 下拉調整織帶，調整肩帶至適當長度，以配合兒童身形(43)

！ 確保兒童與肩帶之間須可以放進一個手掌的厚度。

拆卸座布

- 1- 打開安全扣(44)，移除小座墊。
 - 2- 解開黏扣帶移除肩帶護片(45)
 - 3- 打開座布兩側的鈕扣(46)
 - 4- 解開鈕扣，將肩帶移到頭靠後面(47)(48)
 - 5- 解開頭靠上的鬆緊帶，然後移除頭靠座布(49)(50)
 - 6- 解開調整織帶和座布之間的黏扣帶，然後移除座布(51)
- 反向操作即可組裝冬夏兩用座布。說明書儲存位置如(52)所示。

維修與保養

小座墊支撐塊拆除後，請將其存放於兒童無法接觸到的地方。

請以30度以下水溫清洗。

請勿使用熨斗熨燙。

請勿使用漂白劑及乾洗。

請勿使用未經稀釋的中性清潔劑、汽油或其他有機溶劑清洗 兒童保護裝置，否則可能對兒童保護裝置造成損壞。

使用溫和的洗滌劑，水和柔軟的布清洗兒童保護裝置。

請勿大力扭乾，過分大力扭乾可能留下皺褶。

請於陰涼處鋪平晾乾。

當長時間不使用本兒童保護裝置時，請將本兒童保護裝置從 汽車座椅上拆除，並存放於陰涼處及兒童不易接觸的地方。

汽車安裝資訊

此兒童保護裝置被歸類為“半通用型”ISOFIX兒童保護裝置，適用安裝在大部分(並非全部)之車輛座椅位置。下圖中的數字與“汽車安裝資訊”內的數字相對應。其他車輛型式亦有可能適用此兒童保護裝置，以下車型為車款安裝適配性資料。若有疑問，請洽兒童保護裝置製造商或進口商。

請勿將本兒童保護裝置安裝在汽車前座上。

切勿將後向兒童保護裝置裝置於有空氣囊之前排座椅位置，防止發生死亡或嚴重傷害。

- 表示汽車座椅可安裝本兒童保護裝置。
- x 表示汽車座椅不可安裝本兒童保護裝置。

 表示用電或其它混合驅動的車輛。

 表示符合i-size的車輛。

SB! 表示汽車地板下有儲存盒。消費者要參考汽車使用手冊在儲存盒內使用支撐腳。

如果您的汽車品牌未被列入本說明書或未用“•”或“x”進行標示，請查閱您的汽車手冊或聯絡兒童保護裝置製造商，以進一步了解相關資訊。

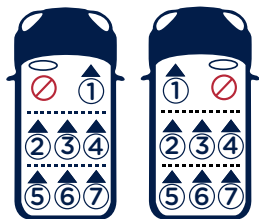

Alfa Romeo

Giulia (2017>)	X	•	X	•	-	-	-	-
Giulietta (2010 - 2016)	X	•	X	•	-	-	-	-
Giulietta (2016>)	X	•	X	•	-	-	-	-
MiTo (2009 - 2016)	X	•	-	•	-	-	-	-
MiTo (2016>)	X	•	-	•	-	-	-	-
Stelvio (2017>)	X	•	X	•	-	-	-	-
156 Sportswagon (1997 - 2005)	X	•	X	•	-	-	-	-
159 (2005 - 2011)	X	•	X	•	-	-	-	-

Audi

A1 (2010 - 2012)	X	•	X	•	-	-	-	-
A1 Sportback (2012 - 2014)	X	•	X	•	-	-	-	-
A1 Sportback (2014>)	X	•	X	•	-	-	-	-
A3 (1996 - 2003)	X	•	X	•	-	-	-	-
A3 (2004 - 2011)	X	•	X	•	-	-	-	-
A3 Hatch (2012 - 2016)	X	•	X	•	-	-	-	-
AS/S3 (2012 - 2016)	X	•	X	•	-	-	-	-
A3 e-Tron Sportback (2013 - 2016)	X	•	X	•	-	-	-	-
A3/S3 Saloon (2014>)	X	•	X	•	-	-	-	-
A3 Saloon (2016>)	X	•	X	•	-	-	-	-
A4 (2005 - 2009)	X	•	X	•	-	-	-	-
A4/S4 (2009 - 2014)	X	•	X	•	-	-	-	-
A4 (2012 - 2016)	X	•	X	•	-	-	-	-
A4/S4 (2015>)	X	•	X	•	-	-	-	-
A4 Allroad (2008 - 2016)	X	•	X	•	-	-	-	-
A4/S4 Avant (2008 - 2016)	X	•	X	•	-	-	-	-
A4 Avant (2015>)	X	•	X	•	-	-	-	-
A4/S4 Saloon (2008 - 2015)	X	•	X	•	-	-	-	-
A4 Saloon (2015>)	X	•	X	•	-	-	-	-
A5 (2007 - 2011)	X	•	X	•	-	-	-	-
A5 (2016>)	X	•	-	•	-	-	-	-
A5 Coupe (2006 - 2016)	X	•	-	•	-	-	-	-
A5 Coupe (2016>)	X	•	-	•	-	-	-	-
A5/S5 Coupe (2016>)	X	•	-	•	-	-	-	-
A5/S5 Sportback (2007 - 2016)	X	•	X	•	-	-	-	-
A5/S5 Sportback (2017>)	X	•	X	•	-	-	-	-
A6 (2011>)	X	•	X	•	-	-	-	-
A6/S6 (2011 - 2014)	X	•	X	•	-	-	-	-
A6/S6 (2014 - 2018)	X	•	X	•	-	-	-	-

① ② ③ ④ ⑤ ⑥ ⑦

A6 Allroad (2011 - 2016)	X	.	X	.	-	-	-
A6 Allroad (2016>)	X	.	X	.	-	-	-
A6 Avant (2011 - 2014)	X	.	X	.	-	-	-
A7 Sportback (2010 - 2014)	X	.	X	.	-	-	-
A7/S7 Sportback (2014 - 2017)	X	.	X	.	-	-	-
A7 Sportback (2017>)	X	.	X	.	-	-	-
A8 (2011 - 2013)	X	.	X	.	-	-	-
A8/S8 (2011 - 2013)	X	.	X	.	-	-	-
A8 (2017>)	X	.	X	.	-	-	-
Q2 (2016>)	X	.	X	.	-	-	-
Q3 (2011 - 2017)	X	.	X	.	-	-	-
Q3 (2017>)	X	.	X	.	-	-	-
Q5 (2008 - 2012)	X	.	X	.	-	-	-
Q5/SQ5 (2012 - 2016)	X	.	X	.	-	-	-
Q5 (2016>)	X	.	X	.	-	-	-
Q7 (2006 - 2015)	X	.	X	.	-	-	-
 Q7/SQ7 (2015>)	X	.	X	.	X	-	X
Q7 (2015>)	X	.	X	.	-	-	-
Q8 (2018>)	X	.	X	.	-	-	-
S1 (2014>)	X	.	X	.	-	-	-
TT Coupe (2006 - 2014)	X	X	-	X	-	-	-
TT Coupe Sport (2014>)	X	.	X	.	-	-	-



Bentley

Continental Flying Spur (2005 - 2008)	X	.	X	.	-	-	-
Continental GT (2003 - 2012)	X	.	-	-	-	-	-
Continental GTC (2006 - 2012)	X	.	-	-	-	-	-
Mulsanne (2009 - 2016)	X	.	X	.	-	-	-

BMW

1-Series 5dr (2004 - 2011)	X	.	X	.	-	-	-
1 Series F20 (2011 - 2015)	X	.	X	.	-	-	-
1-Series Convertible (2008 - 2015)	X	.	-	-	-	-	-
1-Series Coupe (2008 - 2015)	X	.	-	-	-	-	-
2-Series AC-T (2015 - 2018)	X	.	X	.	-	-	-
2-Series Coupe (2014>)	X	.	-	-	-	-	-
2-Series Gran Tourer (2018>)	X	.	X	.	-	-	-
3-GT (2013>)	X	.	X	.	-	-	-
3-Series (2005 - 2011)	X	.	-	-	-	-	-

① ② ③ ④ ⑤ ⑥ ⑦

3 Series F30 (2012>)	X	.	X	.	-	-	-
3-Series Coupe (2007 - 2014)	X	.	-	-	-	-	-
4-Series Gran Coupe (2014 - 2018)	X	.	X	.	-	-	-
5-GT (2009 - 2013)	X	.	X	.	-	-	-
5-Series (2008 - 2010)	X	.	X	.	-	-	-
5-Series (2010 - 2016)	X	.	X	.	-	-	-
5-Series Saloon (2003 - 2010)	X	.	X	.	-	-	-
5-Series Saloon (2011 - 2016)	X	.	X	.	-	-	-
5-Series Touring (2003 - 2010)	X	.	X	.	-	-	-
5-Series Touring (2010 - 2017)	X	.	X	.	-	-	-
6-Series Convertible (2012 - 2015)	X	.	-	-	-	-	-
6-Series Coupe (2dr) (2011 - 2015)	X	.	-	-	-	-	-
6-Series Gran Coupe (4dr) (2011 - 2015)	X	.	X	.	-	-	-
7-Series (2008 - 2012)	X	.	X	.	-	-	-
7-Series (2016>)	X	.	X	.	-	-	-
 i3 (2013 - 2017)	X	.	-	-	-	-	-
M5 (2011 - 2016)	X	.	X	.	-	-	-
M Sport Saloon (2015>)	X	.	X	.	-	-	-
X1 (2009 - 2016)	X	.	X	.	-	-	-
 X1 (2016>)	X	.	X	.	-	-	-
X2 (2018>)	X	.	X	.	-	-	-
X3 F25 (2010 - 2013)	X	.	X	.	-	-	-
X4 (2014 - 2018)	X	.	X	.	-	-	-
X5 (2007- 2014)	X	.	X	.	X	-	X
X5 (2014>)	X	.	X	.	X	-	X
X5 M (2014>)	X	.	X	.	X	-	X
X6 (2008 - 2009)	X	.	X	.	-	-	-
X6 (2010 - 2014)	X	.	X	.	-	-	-
X6 (2014>)	X	.	X	.	-	-	-
X6 M (2014>)	X	.	X	.	-	-	-

Cadillac

BLS Saloon (2006 - 2011)	X	.	X	.	-	-	-
CTS (2003 - 2007)	X	.	X	.	-	-	-

Chevrolet

① ② ③ ④ ⑤ ⑥ ⑦

Aveo 5dr (2011 - 2015)	X	.	X	.	-	-	-
Camaro (2011 - 2015)	X	.	X	.	-	-	-
Captiva (2007 - 2015)	X	.	X	.	-	-	-
Cruze (2009 - 2014)	X	.	X	.	-	-	-
Epica (2006 - 2011)	X	.	X	.	-	-	-
HHR (2007 - 2011)	X	.	X	.	-	-	-
Kalos (2002 - 2007)	X	.	X	.	-	-	-
Lacetti (2002 - 2009)	X	.	X	.	-	-	-
Malibu (2012 - 2016)	X	.	X	.	-	-	-
Matiz (2005 - 2009)	X	.	X	.	-	-	-
Nubira (2004 - 2009)	X	.	X	.	-	-	-
Orlando (2011>)	X	.	X	.	-	-	-
Spark (2010 - 2015)	X	.	X	.	-	-	-
Traxx (2013 - 2017)	X	.	X	.	-	-	-
Volt (2011 - 2016)	X	.	.	.	-	-	-

Chrysler

300C (2012 - 2015)	X	.	X	.	-	-	-
Delta (2007 - 2014)	X	.	X	.	-	-	-
Delta (2008 - 2013)	X	.	X	.	-	-	-
Dodge Avenger (2007 - 2014)	X	.	X	.	-	-	-
Dodge Caliber (2006 - 2012)	X	.	X	.	-	-	-
Dodge Journey (2008 - 2011)	X	.	.	.	-	-	-
Dodge Nitro (2006 - 2011)	X	.	X	.	-	-	-
Dodge Ram (2002 - 2008)	X	.	.	.	-	-	-
Grand Voyager (2001 - 2007)	X	.	.	.	X	X	X
Pacifica (2003 - 2008)	X	.	X	.	-	-	-
PT Cruiser (2001 - 2010)	X	.	X	.	-	-	-
Sebring (2007 - 2010)	X	.	X	.	-	-	-
Voyager (2001 - 2007)	X	.	X
Ypsilon (2011 - 2015)	X	.	X	.	-	-	-

Citroen

① ② ③ ④ ⑤ ⑥ ⑦

SB! Berlingo II (2008 - 2012)	X	.	X	.	-	-	-
SB! Berlingo Multispace (2007 - 2018)	X	.	X	.	X	-	X
C1 (2006 - 2015)	X	.	-	X	-	-	-
C1 (2014>)	X	.	-	-	-	-	-
C2 (2003 - 2009)	X	.	.	.	-	-	-
C3 5dr (2005 - 2009)	X	.	X	.	-	-	-
C3 5dr (2009 - 2016)	X	.	X	.	-	-	-
C3 5dr (2016>)	X	.	X	.	-	-	-
SB! C3 Picasso (2008 - 2012)	X	.	X	.	-	-	-
C4 (2010 - 2018)	X	.	X	.	-	-	-
SB! C4 G-Picasso (2006 - 2013)	X	.	X	.	X	X	X
SB! C4 Picasso (2007 - 2010)	X	.	X	.	X	X	X
SB! C4 Picasso (2013 - 2018))	X	.	X	.	X	-	X
C4-Cactus (2014 - 2018)	X	.	X	.	-	-	-
C5 (2005 - 2008)	X	.	X	.	-	-	-
C5 Saloon (2008 - 2016)	X	.	X	.	-	-	-
C5 Tourer (2008 - 2018)	X	.	X	.	-	-	-
C-Crosser (2007 - 2013)	X	.	X	.	-	-	-
DS3 (2009 - 2014)	X	.	X	.	-	-	-
DS3 Cabrio (2016>)	X	.	X	.	-	-	-
DS4 (2011 - 2015)	X	.	X	.	-	-	-
DS5 (2012 - 2015)	X	.	X	.	-	-	-
Evasion (1998 - 2002)	X	.	X	.	.	X	.
Jumpy (2007 - 2012)	X	.	X	.	X	X	X
Nemo (2008 - 2015)	X	.	X	.	-	-	-
Saxo (1996 - 2003)	X	.	X	.	-	-	-
Xsara (2000 - 2006)	X	X	X	X	-	-	-

Dacia

Dokker (2012>)	X	-	-
Duster (2012 - 2017)	X	.	X	.	-	-	-
Duster (2017>)	X	.	X	.	-	-	-
Lodgy (2012>)	X	-	-
Logan MCV (2012 - 2016)	X	.	X	.	-	-	-
Logan MCV (2016>)	X	.	X	.	-	-	-
Sandero (2012 - 2016)	X	.	X	.	-	-	-
Sandero (2016>)	X	.	X	.	-	-	-

Daihatsu

① ② ③ ④ ⑤ ⑥ ⑦



Cuore (2007 - 2011)	X	.	X	.	-	-	-
Materia (2006 - 2011)	X	.	X	.	-	-	-
Sirion (2001 - 2005)	X	.	X	.	-	-	-
Terios (2005>)	X	.	X	.	-	-	-
Trevis (2004 - 2009)	X	.	X	.	-	-	-

Fiat

124 Spider (2016>)	X	-	-	-	-	-	-
500 (2008>)	X	.	-	.	-	-	-
500 C (2009>)	X	.	-	.	-	-	-
500L (2012>)	X	.	X	.	-	-	-
500X (2015 - 2018)	X	.	X	.	-	-	-
Abarth 500 (2009 - 2015)	X	.	-	.	-	-	-
Abarth 595 (2018>)	X	.	-	.	-	-	-
Abarth Grande Punto (2008 - 2011)	X	.	X	.	-	-	-
GBT Punto (2014>)	X	.	X	.	-	-	-
Bravo (2007 - 2010)	X	.	X	.	-	-	-
Croma (2005 - 2011)	X	.	X	.	-	-	-
Doblo (2005 - 2010)	X	.	X	.	-	-	-
Doblo (2010>)	X	.	X	.	-	-	-
Grande Punto (2006 - 2009)	X	.	X	.	-	-	-
Idea (2003 - 2007)	X	.	X	.	-	-	-
Linea (2006 - 2015)	X	.	X	.	-	-	-
Multipla (2004 - 2007)	X	.	X	.	-	-	-
Panda (2011>)	X	.	X	.	-	-	-
Qubo (2008>)	X	.	X	.	-	-	-
Scudo II (2007 - 2016)	X	.	X	.	.	X	.
Sedici (2006 - 2011)	X	.	X	.	-	-	-
Stilo (2001 - 2007)	X	.	X	.	-	-	-
Tipo (2015>)	X	.	X	.	-	-	-
Ulysse (2002 - 2007)	X	X	.

Ford

① ② ③ ④ ⑤ ⑥ ⑦

 B-Max (2012>)	X	.	X	.	-	-	-
C-Max (2003 - 2010)	X	X	X	X	-	-	-
C-Max (2010 - 2012)	X	.	X	.	-	-	-
C-Max (2011>)	X	.	X	.	-	-	-
Grand C-Max (2010 - 2014)	X	.	X	.	-	-	-
Grand C-Max (2015>)	X	.	X	.	-	-	-
EcoSport (2013 - 2017)	X	.	X	.	-	-	-
EcoSport (2017>)	X	.	X	.	-	-	-
Edge (2015 - 2018)	X	.	X	.	X	-	X
Edge Sport (2018>)	X	.	X	.	-	-	-
Fiesta (2004 - 2008)	X	X	X	X	-	-	-
Fiesta (2008 - 2017)	X	.	X	.	-	-	-
Fiesta 3dr (2017>)	X	.	X	.	-	-	-
Fiesta 5dr (2017>)	X	.	X	.	-	-	-
Fiesta Active (2018>)	X	.	X	.	-	-	-
Focus (1998 - 2005)	X	X	X	X	-	-	-
Focus (2005 - 2009)	X	X	X	X	-	-	-
Focus (2010 - 2015)	X	.	X	.	-	-	-
Focus (2014 - 2018)	X	.	X	.	-	-	-
Focus (2018>)	X	.	X	.	-	-	-
Focus Estate (2011 - 2018)	X	.	X	.	-	-	-
 Focus EV (2014 - 2018)	X	.	X	.	-	-	-
Focus RS (2018>)	X	.	X	.	-	-	-
Focus ST Estate (2017>)	X	.	X	.	-	-	-
SB! Galaxy (2006 - 2015)	X	.	X	.	X	-	X
SB! Galaxy (2016>)	X	.	X	.	X	-	X
Ka (2009 - 2016)	X	.	-	.	-	-	-
Ka+ (2016 - 2018)	X	.	X	.	-	-	-
Ka+ (2018>)	X	.	X	.	-	-	-
Kuga (2012 - 2016)	X	.	X	.	-	-	-
Kuga (2016>)	X	.	X	.	-	-	-
Maverick (2000 - 2007)	X	.	X	.	-	-	-
Mondeo (2002 - 2007)	X	X	X	X	-	-	-
Mondeo (2007 - 2010)	X	.	X	.	-	-	-
Mondeo (2014>)	X	.	X	.	-	-	-
Mondeo Estate (2007 - 2015)	X	.	X	.	-	-	-
Mondeo Estate (2015>)	X	.	X	.	-	-	-
Mondeo Hatchback (2007 - 2015)	X	.	X	.	-	-	-
Mondeo Ranger (2011 - 2015)	X	.	X	.	-	-	-
Mondeo Saloon (2007 - 2015)	X	.	X	.	-	-	-

① ② ③ ④ ⑤ ⑥ ⑦

Mondeo Turnier (2007 - 2014)	X	.	X	.	-	-	-
Mondeo Vignale (2018>)	X	.	X	.	-	-	-
SB! S-Max (2006 - 2014)	X	.	X	.	X	-	X
SB! S-Max (2014>)	X	.	.	.	X	-	X
Tourneo Connect (2009 - 2013)	X	.	X	.	-	-	-
Tourneo Custom (2012>)	X	.	.	X	.	-	-
Transit Connect (2003 - 2007)	X	.	.	X	-	-	-
Transit Kombi (2006 - 2013)	X	.	.	X	-	-	-
Transit Custom (2012>)	X	.	.	X	.	-	-
Vignale (2018>)	X	.	X	.	-	-	-

Honda

Accord Saloon (2008 - 2012)	X	.	X	.	-	-	-
Accord Tourer (2008 - 2015)	X	.	X	.	-	-	-
City (2008 - 2014)	X	.	X	.	-	-	-
Civic (2006 - 2011)	X	.	X	.	-	-	-
Civic (2012 - 2015)	X	.	X	.	-	-	-
Civic (2016>)	X	.	X	.	-	-	-
Civic Hybrid Saloon (2006 - 2010)	X	.	X	.	-	-	-
Civic Prestige (2006 - 2010)	X	.	X	.	-	-	-
Civic Tourer (2013>)	X	.	X	.	-	-	-
Civic Type R (2007 - 2010)	X	.	X	.	-	-	-
CR-V (2007 - 2011)	X	.	X	.	-	-	-
CR-V (2011 - 2016)	X	.	X	.	-	-	-
CR-V (2016 - 2019)	X	.	X	.	-	-	-
CR-Z (2010 - 2016)	X	.	X	.	-	-	-
Elysion (2004 - 2013)	X	.	-	.	X	-	X
FRV (2005 - 2011)	X	.	X	.	-	-	-
HR-V (2014 - 2018)	X	.	X	.	-	-	-
 HR-V (2018 >)	X	.	X	.	-	-	-
Insight (2009 - 2012)	X	.	X	.	-	-	-
Jazz (2001 - 2008)	X	.	X	.	-	-	-
Jazz (2008 - 2015)	X	.	X	.	-	-	-
Jazz (2013 - 2017)	X	.	X	.	-	-	-
Jazz (2017>)	X	.	X	.	-	-	-
Jazz Sport (2017>)	X	.	X	.	-	-	-
Legend (2006 - 2010)	X	.	X	.	-	-	-
Odyssey (2008 - 2011)	X	.	-	.	-	-	-

Hyundai

① ② ③ ④ ⑤ ⑥ ⑦

Accent (1999 - 2003)	X	.	X	.	-	-	-
Coupe (1996 - 2002)	X	.	X	.	-	-	-
Elantra (2000 - 2003)	X	.	X	.	-	-	-
Excel (2002 - 2006)	X	.	X	.	-	-	-
Getz (2002 - 2005)	X	.	X	.	-	-	-
Getz (2005 - 2011)	X	.	X	.	-	-	-
Grandeur (2005 - 2011)	X	.	X	.	-	-	-
i10 (2008 - 2013)	X	.	X	.	-	-	-
i10 Hatch (2008 - 2013)	X	.	X	.	-	-	-
i10 (2016>)	X	.	X	.	-	-	-
i20 Hatch (2009 - 2014)	X	.	X	.	-	-	-
i20 (2014 - 2018)	X	.	X	.	-	-	-
i20 (2018>)	X	.	X	.	-	-	-
i30 (2012 - 2015)	X	.	X	.	-	-	-
i30 (2016>)	X	.	X	.	-	-	-
i40 (2011 - 2018)	X	.	X	.	-	-	-
i40 (2018>)	X	.	X	.	-	-	-
i800/H1 (2008>)	X	.	X	.	X	X	X
Ioniq (2016>)	X	.	X	.	-	-	-
iX20 (2010>)	X	.	X	.	-	-	-
iX35 (2009 - 2013)	X	.	X	.	-	-	-
iX55 (2009>)	X	.	X	.	-	-	-
Kona (2017>)	X	.	X	.	-	-	-
Matrix (2001 - 2010)	X	.	X	.	-	-	-
Pony (2002 - 2006)	X	.	X	.	-	-	-
Santa Fe (2000 - 2004)	X	.	X	.	-	-	-
Santa Fe (2007 - 2012)	X	.	X	.	X	-	X
Santa Fe (2012 - 2016)	X	.	X	.	-	-	-
Santa Fe (2016>)	X	.	X	.	-	-	-
Tucson (2004 - 2009)	X	.	X	.	-	-	-
Tucson (2009 - 2013)	X	.	X	.	-	-	-
Tucson (2013 - 2016)	X	.	X	.	-	-	-
Tucson (2018>)	X	.	X	.	-	-	-
Veloster (2011 - 2018)	X	.	-	.	-	-	-
Verna (1999 - 2005)	X	.	X	.	-	-	-

Infiniti

① ② ③ ④ ⑤ ⑥ ⑦

EX SUV (2009 - 2015)	X	.	X	.	-	-	-
FX SUV (2008 - 2013)	X	.	X	.	-	-	-
G 70 (2016>)	X	.	X	.	-	-	-
G Coupe (2009 - 2013)	X	.	-	.	-	-	-
G Saloon (2009 - 2013)	X	.	X	.	-	-	-
M Saloon (2010 - 2014)	X	.	X	.	-	-	-

Isuzu

D-Max (2004 - 2014)	X	.	X	.	-	-	-
---------------------	---	---	---	---	---	---	---

Jaguar





E-Pace (2017>)	X	.	X	.	-	-	-
F-Pace (2015>)	X	.	X	.	-	-	-
F-Type Coupe (2014 - 2017)	X	.	-	-	-	-	-
S-Type (1999 - 2002)	X	.	X	.	-	-	-
X-Type (2001 - 2010)	X	X	X	X	.	-	-
X-Type Estate (2004 - 2010)	X	X	X	X	.	-	-
XE (2015 - 2018)	X	.	X	.	-	-	-
XF (2008 - 2012)	X	.	X	.	-	-	-
 XF (2015 >)	X	.	X	.	-	-	-
XF R (2009>)	X	.	X	.	-	-	-
XF Sportbrake (2012 - 2015)	X	.	X	.	-	-	-
XF Sportbrake (2017>)	X	.	X	.	-	-	-
XJ (1997 - 2003)	X	.	X	.	-	-	-
XJ (2009 - 2012)	X	.	X	.	-	-	-
XJ (2012>)	X	.	X	.	-	-	-
XK Convertible (2006 - 2009)	X	.	-	.	-	-	-
XK Coupe (2006 - 2009)	X	.	-	.	-	-	-
XK R (2006 - 2008)	X	.	-	.	-	-	-

Jeep

① ② ③ ④ ⑤ ⑥ ⑦

Cherokee (2013 - 2018)	X	.	X	.	-	-	-
Commander (2005 - 2007)	X	.	X	.	-	-	-
Compass (2011 - 2016)	X	.	X	.	-	-	-
Grand Cherokee (2010 - 2013)	X	.	X	.	-	-	-
Grand Patriot (2007 - 2014)	X	.	X	.	-	-	-
Renegade (2014 - 2018)	X	.	X	.	-	-	-
Wrangler 5dr (2006 - 2018)	X	.	X	.	-	-	-

Kia

Carens (2002 - 2006)	X	.	X	.	-	-	-
SB! Carens (2013>)	X	.	.	.	X	-	X
Carnival (2002 - 2006)	X	.	X
Cee'D (2005 - 2015)	X	.	X	.	-	-	-
Cee'D Hatch (2012 - 2015)	X	.	X	.	-	-	-
Cee'D Hatch (2018>)	X	.	X	.	-	-	-
Magentis (2002 - 2005)	X	.	X	.	-	-	-
Mentor (1992 - 2003)	X	.	X	.	-	-	-
Niro (2018>)	X	.	X	.	-	-	-
Opirus (2003 - 2010)	X	.	X	.	-	-	-
Optima (2011 - 2015)	X	.	X	.	-	-	-
 Optima (2016>)	X	.	X	.	-	-	-
Picanto (2004 - 2007)	X	.	X	.	-	-	-
Picanto (2011 - 2015)	X	.	X	.	-	-	-
Picanto (2017>)	X	.	X	.	-	-	-
Rio (2012 - 2016)	X	.	X	.	-	-	-
Rio (2016>)	X	.	X	.	-	-	-
Sephia (1997 - 2003)	X	.	X	.	-	-	-
Shuma (2001 - 2004)	X	.	X	.	-	-	-
Sorento (2010 - 2014)	X	.	X	.	-	-	-
Sorento (2014 - 2017)	X	.	X	.	X	-	X
Soul (2008 - 2013)	X	.	X	.	-	-	-
 Soul EV (2013 - 2018)	X	.	X	.	-	-	-
 Soul (2018>)	X	.	X	.	-	-	-
Spectra (2000 - 2009)	X	.	X	.	-	-	-
Sportage (2011 - 2015)	X	.	X	.	-	-	-
Sportage (2015 - 2018)	X	.	X	.	-	-	-
 Sportage (2018>)	X	.	X	.	-	-	-
Stonic (2017>)	X	.	X	.	-	-	-
Venga (2009 - 2014)	X	.	X	.	-	-	-

	①	②	③	④	⑤	⑥	⑦		①	②	③	④	⑤	⑥	⑦
Lancia															
								NX (2017>)	X	.	X	.	-	-	-
								RC 3dr (2018>)	X	.	X	.	-	-	-
Delta (2008 - 2013)	X	.	X	.	-	-	-	RX300/RX400 (2004 - 2008)	X	.	X	.	-	-	-
Flavia Convertible (2012 - 2015)	X	.	X	.	-	-	-	RX450h (2008 - 2012)	X	.	X	.	-	-	-
Musa (2003 - 2012)	X	.	X	.	-	-	-	RX (2012 - 2016)	X	.	X	.	-	-	-
Phedra (2002 - 2010)	X	.	X	.	-	-	-	RX (2016>)	X	.	X	.	-	-	-
Thema (2011 - 2014)	X	.	X	.	-	-	-	RXL (2018>)	X	.	X	.	-	-	-
Voyager (2010 - 2015)	X	.	-	.	X	X	X								
Ypsilon (2003 - 2006)	X	.	X	.	-	-	-								
Ypsilon (2011 - 2015)	X	.	X	.	-	-	-								
								Maserati							
Land Rover															
								Gran Turismo (2007>)	X	.	X	.	-	-	-
Discovery 4 (2009 - 2013)	X	.	X	.	-	-	-	Quattroporte (2003 - 2012)	X	.	X	.	-	-	-
Discovery 5 (2013 - 2017)	X	.	X	.	-	.	.								
Discovery 5 (2017>)	X	.	X	.	X	-	X								
Discovery Sport (2014>)	X	.	X	.	X	-	X								
Freelander 2 (2006 - 2009)	X	.	X	.	-	-	-								
Range Rover (2002 - 2012)	X	.	X	.	-	-	-								
Range Rover (2013 - 2017)	X	.	X	.	-	-	-								
Range Rover Evoque 3dr (2011 - 2015)	X	.	X	.	-	-	-								
Range Rover Evoque 5dr (2011 - 2015)	X	.	X	.	-	-	-								
Range Rover Evoque 3dr (2018>)	X	.	X	.	-	-	-								
Range Rover Evoque 5dr (2018>)	X	.	X	.	-	-	-								
Range Rover Sport (2005 - 2012)	X	.	X	.	-	-	-								
Range Rover Sport (2013 - 2017)	X	.	X	.	-	-	-								
⚡ Range Rover Sport (2017>)	X	.	X	.	-	-	-								
Range Rover Velar (2017>)	X	.	X	.	-	-	-								
Range Rover Vogue (2018>)	X	.	X	.	-	-	-								
Lexus															
								2 (2007 - 2014)	X	.	X	.	-	-	-
CT (2011 - 2014)	X	.	X	.	-	-	-	2 (2014>)	X	.	X	.	-	-	-
CT (2017>)	X	.	X	.	-	-	-	3 Hatchback (2009 - 2013)	X	.	X	.	-	-	-
GS (2000 - 2011)	X	.	X	.	-	-	-	3 Hatchback (2013 - 2016)	X	.	X	.	-	-	-
GS (2013>)	X	.	X	.	-	-	-	3 Saloon (2009 - 2013)	X	.	X	.	-	-	-
⚡ GSh (2013>)	X	.	X	.	-	-	-	323 (1998 - 2003)	X	.	X	.	-	-	-
IS Saloon (2005 - 2012)	X	.	X	.	-	-	-	5 (2005 - 2010)	X	.	X	.	-	-	-
IS Saloon (2016>)	X	.	X	.	-	-	-	6 (2002 - 2008)	X	.	X	.	-	-	-
LS430 (1997 - 2000)	X	.	X	.	-	-	-	6 Hatch (2007 - 2012)	X	.	X	.	-	-	-
⚡ LS500h (2017>)	X	.	X	.	-	-	-	6 (2018>)	X	.	X	.	-	-	-
NX (2014 - 2017)	X	.	X	.	-	-	-	6 Estate (2007 - 2013)	X	.	X	.	-	-	-
								6 Estate (2012 - 2017)	X	.	X	.	-	-	-
								6 Estate (2018>)	X	.	X	.	-	-	-
								6 Saloon (2007 - 2009)	X	.	X	.	-	-	-
								6 Saloon (2009 - 2013)	X	.	X	.	-	-	-
								CX-3 (2015 - 2018)	X	.	X	.	-	-	-
								CX-5 (2012 - 2016)	X	.	X	.	-	-	-
								CX-5 (2016>)	X	.	X	.	-	-	-
								CX-7 (2007 - 2011)	X	.	X	.	-	-	-
								Demio (2002 - 2007)	X	.	X	.	-	-	-
								MPV (1999 - 2004)	X	.	X	.	-	-	-
								MX-5 (1998 - 2005)	X	.	-	-	-	-	-

① ② ③ ④ ⑤ ⑥ ⑦

MX-5 (2015>)	X	-	-	-	-	-
Premacy (1999 - 2005)	X	•	X	•	-	-
RX-8 (2003 - 2010)	X	•	X	•	-	-
Tribute (2001 - 2004)	X	•	X	•	-	-
Verisa (2004>)	X	•	X	•	-	-

Mercedes-Benz

A Class (2001 - 2005)	X	•	X	•	-	-
A Class (2005 - 2012)	X	•	X	•	-	-
A-Class (2012 - 2018)	X	•	X	•	-	-
B-Class (2011 - 2014)	X	•	X	•	-	-
⚡ B-Class EV (2014 - 2018)	X	•	X	•	-	-
C-Class (2000 - 2007)	X	•	X	•	-	-
C-Class (2007 - 2014)	X	•	X	•	-	-
C-Class Coupe (2011 - 2013)	X	•	-	•	-	-
C-Class Estate (2007 - 2011)	X	•	X	•	-	-
C-Class Estate (2014>)	X	•	X	•	-	-
Citan (2012>)	X	•	X	•	-	-
CLA (2013 - 2016)	X	•	X	•	-	-
CLC (2008 - 2012)	X	•	X	•	-	-
CLK (2002 - 2010)	X	•	X	•	-	-
CLS Coupe (2004 - 2010)	X	•	X	•	-	-
CLS Coupe (2011 - 2016)	X	•	X	•	-	-
CLS Coupe (2016>)	X	•	X	•	-	-
CLS Shooting Brake (2012 - 2017)	X	•	X	•	-	-
E-Class (2002 - 2009)	X	•	X	•	-	-
E-Class (2006 - 2009)	X	•	X	•	-	-
E-Class (2016>)	X	•	X	•	-	-
E-Class Coupe (2009 - 2012)	X	•	-	•	-	-
E-Class Estate (2013 - 2016)	X	•	X	•	-	-
E-Class Saloon (2009 - 2016)	X	•	X	•	-	-
E-Class Saloon (2016>)	X	•	X	•	-	-
GL Class (2006 - 2012)	X	•	X	•	X	•
GL Class (2012 - 2016)	X	•	X	•	•	•
GLA (2013 - 2017)	X	•	X	•	-	-
GLC SUV (2015>)	X	•	X	•	-	-
GLE (2015 - 2019)	X	•	X	•	-	-
GLK (2008 - 2015)	X	•	X	•	-	-
GLS (2016>)	X	•	X	•	•	•
M (2011 - 2015)	X	•	X	•	-	-

① ② ③ ④ ⑤ ⑥ ⑦

M-Klasse (1997 - 2005)	X	•	X	•	-	-
ML-Class (2005 - 2012)	X	•	X	•	-	-
ML-Class (2012 - 2015)	X	•	X	•	-	-
R-Class (2005 - 2012)	X	•	X	•	-	-
S Class (2005 - 2015)	X	•	X	•	-	-
S-Class (2015 - 2018)	X	•	X	•	-	-
SL Class (2011 - 2016)	X	-	-	-	-	-
SLK (2011 - 2016)	X	-	-	-	-	-
Sprinter (2006 - 2013)	X	•	X	•	-	-
V-Class (2014 - 2019)	X	X	•	•	X	•
Vaneo (2001 - 2005)	X	•	•	•	-	-
Viano (2003 - 2010)	X	•	X	•	•	•
Vito (2003 - 2014)	X	•	•	X	•	•

MG Rover

25 (1999 - 2005)	X	X	X	X	-	-
GS (2016>)	X	•	X	•	-	-
MG3 (2013>)	X	•	X	•	-	-
Streetwise (1999 - 2005)	X	X	X	X	-	-
ZR (2001 - 2005)	X	X	X	X	-	-
ZT (2003 - 2006)	X	X	X	X	-	-

Mini

Countryman (2010 - 2014)	X	•	X	•	-	-
Countryman 4 (2010 - 2014)	X	•	X	•	-	-
Countryman 5 (2010 - 2014)	X	•	X	•	-	-
Coupe (2009 - 2015)	X	-	-	-	-	-
Hatchback (2006 - 2014)	X	•	-	•	-	-
Hatchback (2014 - 2018)	X	•	-	•	-	-
Hatchback 3dr (2014 - 2018)	X	•	-	•	-	-
Hatchback 5dr (2014 - 2018)	X	•	X	•	-	-
Paceman (2013 - 2016)	X	•	-	•	-	-
R56 (2010 - 2015)	X	•	X	•	-	-
R57 (2007 - 2014)	X	•	X	•	-	-

Mitsubishi

	①	②	③	④	⑤	⑥	⑦
ASX (2010 - 2012)	X	•	X	•	-	-	-
Colt (2004 - 2008)	X	•	X	•	-	-	-
Colt (2007 - 2013)	X	•	X	•	-	-	-
Grandis (2004 - 2011)	X	•	X	•	-	-	-
Lancer (2007 - 2011)	X	•	-	•	-	-	-
Lancer Evo (2003 - 2007)	X	•	-	•	-	-	-
Lancer Ralliart (2009 - 2011)	X	•	-	•	-	-	-
Lancer Sportback (2008 - 2012)	X	•	-	•	-	-	-
Mirage (2012>)	X	•	X	•	-	-	-
Outlander (2003 - 2007)	X	•	X	•	-	-	-
Outlander (2006 - 2013)	X	•	X	•	-	-	-
Outlander (2012 - 2016)	X	•	X	•	-	-	-
⚡ Outlander PHEV (2016>)	X	•	X	•	-	-	-
Pajero (2006>)	X	•	X	•	-	-	-
Shogun (2007 - 2009)	X	•	X	•	-	-	-

Nissan

Almera (2000 - 2002)	X	•	X	•	-	-	-
Juke (2010>)	X	•	X	•	-	-	-
⚡ Leaf EV (2010 - 2017)	X	•	X	•	-	-	-
⚡ Leaf EV (2017>)	X	•	X	•	-	-	-
Maxima (1995 - 2000)	X	•	X	•	-	-	-
Micra (1998 - 2000)	X	•	X	•	-	-	-
Micra (2010 - 2013)	X	•	X	•	-	-	-
Micra (2017>)	X	•	X	•	-	-	-
Murano (2003 - 2007)	X	•	X	•	-	-	-
Murano (2016>)	X	•	X	•	-	-	-
Navara (2001 - 2005)	X	•	X	•	-	-	-
Note (2004 - 2010)	X	•	X	•	-	-	-
Note (2013 - 2017)	X	•	X	•	-	-	-
Pathfinder (2005 - 2007)	X	•	X	•	-	-	-
Pixo (2009 - 2013)	X	•	X	•	-	-	-
Primera (1996 - 2002)	X	•	X	•	-	-	-
Pulsar (2014>)	X	•	X	•	-	-	-
Qashqai +2 (2008 - 2015)	X	•	X	•	-	-	-
Qashqai (2007 - 2013)	X	•	X	•	-	-	-
Qashqai (2013 - 2018)	X	•	X	•	-	-	-
Qashqai (2018>)	X	•	X	•	-	-	-
Quest MPV (2011>)	X	•	-	•	X	-	X

Opel

	①	②	③	④	⑤	⑥	⑦
Tiida (2004>)	X	•	X	•	-	-	-
2008 X-Trail (2001 - 2007)	X	•	X	•	-	-	-
2008 X-Trail (2007 - 2015)	X	•	X	•	-	-	-
X-Trail (2014 - 2017)	X	•	X	•	X	-	X
X-Trail (2017>)	X	•	X	•	X	-	X
Adam (2013>)	X	•	-	•	-	-	-
Agila (2000 - 2007)	X	•	X	•	-	-	-
Agila (2008 - 2015)	X	•	X	•	-	-	-
⚡ Ampera (2011 - 2015)	X	•	-	•	-	-	-
Antara (2006 - 2015)	X	•	X	•	-	-	-
Astra (2004 - 2010)	X	•	X	•	-	-	-
Astra 5dr (2009 - 2015)	X	•	X	•	-	-	-
🚗 Astra (2015>)	X	•	X	•	-	-	-
Astra Estate (2010 - 2015)	X	•	X	•	-	-	-
Astra GTC (2011>)	X	•	X	•	-	-	-
Caravan (1998 - 2005)	X	•	X	•	-	-	-
Combo (2001 - 2011)	X	•	X	•	-	-	-
Corsa 3dr Hatch (2006 - 2015)	X	•	X	•	-	-	-
Corsa 5dr Hatch (2006 - 2015)	X	•	X	•	-	-	-
Corsa 5dr (2014>)	X	•	X	•	-	-	-
Corsa C (2000 - 2006)	X	•	X	•	-	-	-
Corsa D (2006 - 2014)	X	•	X	•	-	-	-
Corsa VXR (2007 - 2014)	X	•	X	•	-	-	-
Insignia Hatch (2008 - 2013)	X	•	X	•	-	-	-
Insignia Saloon (2008 - 2013)	X	•	X	•	-	-	-
Insignia Sports Tourer (2009 - 2013)	X	•	X	•	-	-	-
Karl (2015>)	X	•	X	•	-	-	-
Meriva (2002 - 2010)	X	•	X	•	-	-	-
Meriva (2010 - 2014)	X	•	X	•	-	-	-
Mokka (2012 - 2016)	X	•	X	•	-	-	-
Signum (2003 - 2008)	X	•	X	•	-	-	-
Vectra (2002 - 2008)	X	•	X	•	-	-	-
Vivaro (2001 - 2014)	X	•	X	•	-	-	-
Zafira (2005 - 2014)	X	•	X	•	-	-	-
Zafira Tourer (2011 - 2016)	X	•	X	•	X	-	X

Peugeot

	①	②	③	④	⑤	⑥	⑦
107 (2005 - 2014)	X	.	-	.	-	-	-
108 3dr (2014>)	X	.	-	.	-	-	-
108 5dr (2014>)	X	.	-	.	-	-	-
206 (1998 - 2009)	X	.	X	.	-	-	-
206 3dr (2004 - 2009)	X	X	X	X	-	-	-
207 3dr (2006 - 2012)	X	.	X	.	-	-	-
207 5dr (2006 - 2012)	X	.	X	.	-	-	-
207 SW (2007 - 2012)	X	.	X	.	-	-	-
208 3dr (2012>)	X	.	X	.	-	-	-
208 5dr (2012>)	X	.	X	.	-	-	-
307 (2001 - 2008)	X	.	X	.	-	-	-
307 Estate (2002 - 2007)	X	.	X	.	-	-	-
308 Hatch (2007 - 2014)	X	.	X	.	-	-	-
308 (2014 - 2017)	X	.	X	.	-	-	-
308 (2017>)	X	.	X	.	-	-	-
308 SW (2008 - 2015)	X	.	X	.	-	-	-
308 SW (2014 - 2017)	X	.	X	.	-	-	-
406 (1999 - 2004)	X	.	X	.	-	-	-
407 (2004 - 2011)	X	.	X	.	-	-	-
407 SW (2004 - 2011)	X	X	X	X	-	-	-
508 (2011 - 2014)	X	.	X	.	-	-	-
508 RXH (2011 - 2014)	X	.	X	.	-	-	-
508 SW (2010 - 2014)	X	.	X	.	-	-	-
607 (2000 - 2009)	X	.	X	.	-	-	-
SB! 807 (2002 - 2010)	X	.	X
1007 (2005 - 2009)	X	.	X	.	-	-	-
2008 (2013>)	X	.	X	.	-	-	-
SB! 3008 (2009 - 2016)	X	.	X	.	-	-	-
3008 (2016>)	X	.	X	.	-	-	-
4007 (2007 - 2012)	X	.	X	.	-	-	-
4008 (2012>)	X	.	X	.	-	-	-
SB! 5008 (2009 - 2013)	X	.	.	.	X	-	X
SB! 5008 (2013>)	X	.	.	.	X	-	X
Bipper (2008 - 2017)	X	.	X	.	-	-	-
Expert Tepee (2007 - 2016)	X	.	X	.	X	X	X
Partner Combi (2004 - 2010)	X	X	X	X	-	-	-
Partner Teepee (2008>)	X	.	X	.	-	-	-
RCZ (2009 - 2013)	X	.	-	.	-	-	-
Traveller (2016>)	X	.	X	.	X	X	X

Pontiac

	①	②	③	④	⑤	⑥	⑦
Grand AM (1998 - 2004)	X	.	X	.	-	-	-

Porsche

Cayenne (2002 - 2006)	X	.	X	.	-	-	-
Cayenne (2010 - 2015)	X	.	X	.	-	-	-
⚡ Cayenne E-Hybrid (2015 - 2017)	X	.	X	.	-	-	-
⚡ Cayenne E-Hybrid (2017>)	X	.	X	.	-	-	-
Macan (2014 - 2018)	X	.	X	.	-	-	-
Macan Turbo (2018>)	X	.	X	.	-	-	-
Panamera (2009 - 2013)	X	.	-	.	-	-	-
⚡ Panamera E-Hybrid (2016>)	X	.	-	.	-	-	-
Panamera Estate (2017>)	X	.	X	.	-	-	-

Renault

Avantime (2001 - 2003)	X	.	X	.	-	-	-
Captur (2013 - 2017)	X	.	X	.	-	-	-
Captur (2017>)	X	.	X	.	-	-	-
Clio (1998 - 2003)	X	.	X	.	-	-	-
Clio (2005 - 2012)	X	.	X	.	-	-	-
Clio (2013 - 2016)	X	.	X	.	-	-	-
Clio (2016>)	X	.	X	.	-	-	-
Clio Sport (2006 - 2012)	X	.	X	.	-	-	-
Clio Sport (2013>)	X	.	X	.	-	-	-
Clio Sport Tourer (2007 - 2012)	X	.	X	.	-	-	-
Clio Sport Tourer (2013 - 2016)	X	.	X	.	-	-	-
Espace (2003 - 2012)	X
Fluence (2009 - 2014)	X	.	X	.	-	-	-
Grand Espace (1998 - 2002)	X
Grand Espace (2002 - 2012)	X
Grand Modus (2008 - 2012)	X	.	X	.	-	-	-
Grand Scenic (2006 - 2009)	X	X	.	X	-	-	-
Kangoo (1997 - 2003)	X	X	.	X	-	-	-
Kangoo (2008 - 2013)	X	.	X	.	-	-	-
Kadjar (2015 - 2018)	X	.	X	.	-	-	-
Kadjar (2018>)	X	.	X	.	-	-	-
Koleos (2016>)	X	.	X	.	-	-	-
Laguna (2001 - 2007)	X	.	X	.	-	-	-
Laguna (2008>)	X	.	X	.	-	-	-

① ② ③ ④ ⑤ ⑥ ⑦

Laguna Grand Tour (2007 - 2010)	X	.	X	.	-	-	-
Laguna Sport Tourer (2008 - 2012)	X	.	X	.	-	-	-
Megane (1996 - 1999)	X	.	X	.	-	-	-
Megane (2006 - 2009)	X	.	X	.	-	-	-
Megane Coupe (2002 - 2006)	X	.	X	.	-	-	-
Megane Grand Tour (1999 - 2003)	X	.	X	.	-	-	-
Megane Grand Tour (2008 - 2016)	X	.	X	.	-	-	-
Megane Hatch (2002 - 2009)	X	.	X	.	-	-	-
SB! Megane Hatch (2008 - 2016)	X	.	X	.	-	-	-
Megane Hatch (2016>)	X	.	X	.	-	-	-
Megane Scenic (2003 - 2009)	X	.	X	.	-	-	-
Megane Sport Tourer (2009 - 2016)	X	.	X	.	-	-	-
Megane Sport Tourer (2016>)	X	.	X	.	-	-	-
Modus (2004 - 2012)	X	.	X	.	-	-	-
Grand Modus (2008 - 2012)	X	.	X	.	-	-	-
Sandero (2012>)	X	.	X	.	-	-	-
Scenic/Grand Scenic (1995 - 1999)	X	.	X	.	-	-	-
SB! Scenic (2003 - 2009)	X	.	X	.	-	-	-
SB! Scenic (2009 - 2016)	X	.	X	.	-	-	-
SB! Scenic (2016>)	X	.	X	.	-	-	-
Trafic (2001 - 2007)	X	X	.	X	.	-	-
Trafic (2007 - 2010)	X	.	.	X	.	-	-
Twingo (1998 - 2007)	X	.	X	.	-	-	-
Twingo (2007 - 2014)	X	.	.	-	-	-	-
Twingo (2014 - 2018)	X	.	.	-	-	-	-
Twingo (2018>)	X	.	.	-	-	-	-
Vel Satis (2002 - 2005)	X	.	X	.	-	-	-
⚡ Zoe (2012>)	X	.	X	.	-	-	-

Saab

9-3 (2002 - 2012)	X	.	X	.	-	-	-
9-3 Sport Wagon (2005 - 2012)	X	.	X	.	-	-	-
9-3 X (2009 - 2012)	X	.	X	.	-	-	-
9-5 (2011 - 2012)	X	.	X	.	-	-	-
9-5 Estate (2005 - 2010)	X	.	X	.	-	-	-

Seat

Alhambra (1995 - 2010)	X	-	-
SB! Alhambra (2010>)	X	-	-
Altea (2004 - 2011)	X	.	X	.	-	-	-
Altea Freerack4 (2007- 2009)	X	.	X	.	-	-	-
Altea XL (2006 - 2011)	X	.	X	.	-	-	-
Arona (2017>)	X	.	X	.	-	-	-
Arosa (1997 - 2004)	X	.	X	.	-	-	-
Ateca Estate (2016>)	X	.	X	.	-	-	-
Cordoba Vario (1996 - 2002)	X	.	-	.	-	-	-
Exeo (2008 - 2014)	X	.	X	.	-	-	-
Exeo ST Estate (2008 - 2014)	X	.	X	.	-	-	-
Ibiza (1993 - 2002)	X	.	X	.	-	-	-
Ibiza (2002 - 2008)	X	.	X	.	-	-	-
Ibiza Cupra (2009 - 2012)	X	.	X	.	-	-	-
Ibiza Hatch (2008 - 2013)	X	.	X	.	-	-	-
Ibiza (2017>)	X	.	X	.	-	-	-
Ibiza FR (2009 - 2017)	X	.	X	.	-	-	-
Inca (1995 - 2003)	X	.	X	.	-	-	-
Leon (1998 - 2005)	X	.	X	.	-	-	-
Leon Hatch (2005 - 2012)	X	.	X	.	-	-	-
Leon (2012>)	X	.	X	.	-	-	-
Leon Cupra (2007 - 2011)	X	.	X	.	-	-	-
Leon Cupra Special Edition (2018>)	X	.	X	.	-	-	-
Leon FR (2006 - 2012)	X	.	X	.	-	-	-
Leon Sport Tourer (2013>)	X	.	X	.	-	-	-
Mii 3dr (2012>)	X	.	X	.	-	-	-
Mii 5dr (2012>)	X	.	X	.	-	-	-
Toledo (1994 - 2004)	X	.	X	.	-	-	-
Toledo (2012>)	X	.	X	.	-	-	-

Skoda

Citigo 3dr (2011 - 2017)	X	.	X	.	-	-	-
Citigo 5dr (2012 - 2017)	X	.	X	.	-	-	-
Citigo 3dr (2017>)	X	.	X	.	-	-	-
Citigo 5dr (2017>)	X	.	X	.	-	-	-
Fabia (1999 - 2007)	X	.	X	.	-	-	-
Fabia Hatch (2007 - 2014)	X	.	X	.	-	-	-
Fabia (2014 - 2018)	X	.	X	.	-	-	-
Fabia (2018>)	X	.	X	.	-	-	-

① ② ③ ④ ⑤ ⑥ ⑦

① ② ③ ④ ⑤ ⑥ ⑦

Fabia Estate Combi (2008 - 2014)	X	.	X	.	-	-	-
Karoq (2017>)	X	.	X	.	-	-	-
Kodiaq (2018>)	X	.	X	.	-	-	-
Octavia (1996 - 2004)	X	.	X	.	-	-	-
Octavia Hatch (2004 - 2012)	X	.	X	.	-	-	-
Octavia Hatch (2013 - 2017)	X	.	X	.	-	-	-
Octavia Hatch (2017>)	X	.	X	.	-	-	-
Octavia Estate Combi (2005 - 2013)	X	.	X	.	-	-	-
Octavia Estate (2017>)	X	.	X	.	-	-	-
Octavia Scout (2007 - 2013)	X	.	X	.	-	-	-
Rapid (2013>)	X	.	X	.	-	-	-
Roomster (2006 - 2015)	X	.	X	.	-	-	-
Superb (2001 - 2008)	X	.	X	.	-	-	-
Superb (2008 - 2014)	X	.	X	.	-	-	-
Superb Estate (2015>)	X	.	X	.	-	-	-
Superb Hatch (2015>)	X	.	X	.	-	-	-
Superb Combi/Estate (2008 - 2013)	X	.	X	.	-	-	-
Yeti (2009 - 2013)	X	.	-	.	-	-	-

Smart

For Two Coupe (2007 - 2011)	X	X	-	X	-	-	-
For Two Coupe (2014>)	X	-	-	-	-	-	-
FourFour (2004 - 2006)	X	.	X	.	-	-	-
FourFour (2014>)	X	.	X	.	-	-	-

Ssangyong

Actyon (2006 - 2011)	X	.	X	.	-	-	-
Korando (2011- 2017)	X	.	X	.	-	-	-
Musso Pickup (2016>)	X	.	X	.	-	-	-
Rexton (2014 - 2016)	X	.	X	.	-	-	-
Tivoli (2015>)	X	.	X	.	-	-	-
Turismo (2013>)	X	.	-	.	X	X	X

Subaru

BRZ (2012>)	X	.	-	.	-	-	-
Forester (2003 - 2008)	X	.	X	.	-	-	-
Forester (2013 - 2018)	X	.	X	.	-	-	-
Impreza 5dr (2007 - 2012)	X	.	X	.	-	-	-
Impreza 5dr (2012 - 2016)	X	.	X	.	-	-	-
Justy (2004 - 2007)	X	.	X	.	-	-	-
Legacy (2003 - 2006)	X	.	X	.	-	-	-
Legacy (2009 - 2014)	X	.	X	.	-	-	-
Outback (2009 - 2014)	X	.	X	.	-	-	-
Sedan (2002 - 2004)	X	.	X	.	-	-	-
Wagon (2002 - 2004)	X	.	X	.	-	-	-
XV Hatchback (2011 - 2015)	X	.	X	.	-	-	-

Suzuki

Alto (2009>)	X	.	X	.	-	-	-
 Baleno (2016>)	X	.	X	.	-	-	-
Grand Vitara (2002 - 2008)	X	.	X	.	-	-	-
Grand Vitara (2008>)	X	.	X	.	-	-	-
Ignis (2003 - 2006)	X	.	X	.	-	-	-
Kizashi (2009>)	X	.	X	.	-	-	-
Liana (2001 - 2007)	X	.	X	.	-	-	-
Splash (2007>)	X	.	X	.	-	-	-
Swift (2004 - 2010)	X	.	X	.	-	-	-
Swift Sport (2011 - 2016)	X	.	X	.	-	-	-
SX-4 (2006 - 2013)	X	.	X	.	-	-	-
SX-4 Saloon (2006>)	X	.	X	.	-	-	-
Vitara (2014>)	X	.	X	.	-	-	-
Wagon R+ (2000 - 2003)	X	.	X	.	-	-	-

TATA

Indica Vista (2008 - 2013)	X	.	X	.	-	-	-
----------------------------	---	---	---	---	---	---	---

Tesla

 Model S (2014>)	X	.	X	.	-	-	-
 Model X (2016>)	X	.	X	.	.	X	.

① ② ③ ④ ⑤ ⑥ ⑦

Toyota

	①	②	③	④	⑤	⑥	⑦
Auris (2007 - 2012)	X	•	X	•	-	-	-
Auris (2013 - 2015)	X	•	X	•	-	-	-
Auris (2018>)	X	•	X	•	-	-	-
Avensis Hatch (2003 - 2011)	X	•	X	•	-	-	-
Avensis Tourer (2009 - 2011)	X	•	X	•	-	-	-
Aygo 3dr (2005 - 2014)	X	•	-	•	-	-	-
Aygo (2014 - 2018)	X	•	-	•	-	-	-
Aygo (2018>)	X	•	-	•	-	-	-
Aygo Explorer (2018>)	X	•	-	•	-	-	-
Camry (1997 - 2001)	X	•	X	•	-	-	-
Corolla (2002 - 2007)	X	•	X	•	-	-	-
C-HR (2016>)	X	•	X	•	-	-	-
EZ MPV (Verso) (2013>)	X	•	X	•	-	-	-
GT86 (2012 - 2016)	X	•	-	-	-	-	-
GT86 (2016>)	X	•	-	-	-	-	-
Highlander (2013 - 2016)	X	•	X	•	-	-	-
IQ (2008 - 2015)	X	•	X	•	-	-	-
Landcruiser (2002 - 2009)	X	•	X	•	-	-	-
Landcruiser (2009 - 2013)	X	•	X	•	-	-	-
Landcruiser (2017>)	X	•	X	•	-	-	-
Previa (2000 - 2009)	X	•	X	•	-	-	-
⚡ Prius (2009 - 2011)	X	•	X	•	-	-	-
⚡ Prius 2 (2004 - 2010)	X	•	X	•	-	-	-
⚡ Prius 3 (2010 - 2016)	X	•	X	•	-	-	-
⚡ Prius 4 (2016>)	X	•	X	•	-	-	-
⚡ Prius Plus+ (2011 - 2015)	X	•	X	•	-	-	-
⚡ Prius PHEV 3 (2015>)	X	•	X	•	-	-	-
RAV4 (2000 - 2006)	X	•	X	•	-	-	-
RAV4 (2013 - 2015)	X	•	X	•	-	-	-
RAV4 (2018>)	X	•	X	•	-	-	-
RAV4 MK3 (2006 - 2011)	X	•	X	•	-	-	-
Urban Cruiser (2009 - 2012)	X	•	X	•	-	-	-
SB! Verso (2009 - 2012)	X	•	X	•	-	-	-
SB! Verso (2013>)	X	•	X	•	-	-	-
Yaris (1999 - 2005)	X	•	X	•	-	-	-
Yaris (2008 - 2011)	X	•	X	•	-	-	-
Yaris Hatch (2011 - 2014)	X	•	X	•	-	-	-
Yaris Hatch (2017>)	X	•	X	•	-	-	-

Vauxhall

	①	②	③	④	⑤	⑥	⑦
Adam (2012>)	X	•	-	•	-	-	-
Agila (2000 - 2007)	X	•	X	•	-	-	-
Agila (2008 - 2013)	X	•	X	•	-	-	-
⚡ Ampera (2011 - 2015)	X	•	-	•	-	-	-
Antara (2006 - 2015)	X	•	X	•	-	-	-
Astra (2004 - 2010)	X	•	X	•	-	-	-
🚗 Astra (2015>)	X	•	X	•	-	-	-
Astra 5dr (2009 - 2015)	X	•	X	•	-	-	-
Astra Estate (2010 - 2012)	X	•	X	•	-	-	-
Astra GTC (2011>)	X	•	X	•	-	-	-
Astra Sport Tourer (2012>)	X	•	X	•	-	-	-
Caravan (1998 - 2005)	X	•	X	•	-	-	-
Combo (2001 - 2011)	X	•	X	•	-	-	-
Corsa 3dr Hatch (2006 - 2015)	X	•	X	•	-	-	-
Corsa 5dr Hatch (2006 - 2015)	X	•	X	•	-	-	-
Corsa 3dr (2014>)	X	•	X	•	-	-	-
Corsa 5dr (2014>)	X	•	X	•	-	-	-
Corsa C (2000 - 2006)	X	•	X	•	-	-	-
Corsa D (2006 - 2014)	X	•	X	•	-	-	-
Corsa VXR (2007 - 2014)	X	•	X	•	-	-	-
Crossland X (2017>)	X	•	X	•	-	-	-
Grandland X (2017>)	X	•	X	•	-	-	-
Insignia Hatch (2008 - 2013)	X	•	X	•	-	-	-
Insignia Hatch (2013>)	X	•	X	•	-	-	-
Insignia Saloon (2008 - 2013)	X	•	X	•	-	-	-
Insignia Sports Tourer (2009 - 2013)	X	•	X	•	-	-	-
Karl (2015>)	X	•	X	•	-	-	-
Meriva (2002 - 2010)	X	•	X	•	-	-	-
Meriva (2010 - 2014)	X	•	X	•	-	-	-
Mokka (2012 - 2016)	X	•	X	•	-	-	-
Mokka X (2012>)	X	•	X	•	-	-	-
Signum (2003 - 2008)	X	•	X	•	-	-	-
Vectra (2002 - 2008)	X	•	X	•	-	-	-
Vivaro (2001 - 2014)	X	•	X	•	-	-	-
Viva (2015>)	X	•	X	•	-	-	-
Zafira (2005 - 2014)	X	•	X	•	-	-	-
Zafira Tourer (2011 - 2016)	X	•	X	•	X	-	X

Volvo

	①	②	③	④	⑤	⑥	⑦
C30 (2006 - 2013)	X	.	-	.	-	-	-
C70 (2005 - 2013)	X	.	X	.	-	-	-
S40 (2003 - 2012)	X	.	X	.	-	-	-
S60 (2010 - 2013)	X	.	X	.	-	-	-
S80 (2006 - 2008)	X	.	X	.	-	-	-
S90 (2016>)	X	.	X	.	-	-	-
V40 (1996 - 2004)	X	.	X	.	-	-	-
V40 (2012 - 2016)	X	.	X	.	-	-	-
V40 (2016>)	X	.	X	.	-	-	-
V40 Cross Country (2012 - 2016)	X	.	X	.	-	-	-
V40 Cross Country (2016>)	X	.	X	.	-	-	-
V50 (2004 - 2012)	X	.	X	.	-	-	-
V60 (2010 - 2013)	X	.	X	.	-	-	-
⚡ V60 PHEV (2014 - 2018)	X	.	X	.	-	-	-
V60 (2018>)	X	.	X	.	-	-	-
V70 (2007- 2016)	X	.	X	.	-	-	-
V90 (2016>)	X	.	X	.	-	-	-
V90 Cross Country (2016>)	X	.	X	.	-	-	-
XC40 (2017>)	X	.	X	.	-	-	-
XC60 (2008 - 2013)	X	.	X	.	-	-	-
XC60 (2013 - 2017)	X	.	X	.	-	-	-
XC60 (2017>)	X	.	X	.	-	-	-
XC70 (2000 - 2007)	X	.	X	.	-	-	-
XC70 (2007 - 2016)	X	.	X	.	-	-	-
XC90 (2003 - 2015)	X	.	X	.	-	-	-
XC90 (2014>)	X	.	X	.	-	-	-

Volkswagen

	①	②	③	④	⑤	⑥	⑦
Amarok (2009 - 2016)	X	.	X	.	-	-	-
Beetle (1998 - 2005)	X	.	-	.	-	-	-
Bora (1998 - 2005)	X	.	X	.	-	-	-
Caddy (2000 - 2010)	X	.	X	.	-	-	-
Caddy (2010 - 2013)	X	.	X	.	X	-	X
Caddy Maxlife (2010 - 2015)	X	.	X	.	X	-	X
⚡ E-Golf Hatch Mk7 (2014 - 2016)	X	.	X	.	-	-	-
EOS (2006 - 2011)	X	.	X	.	-	-	-
Fox (2005>)	X	.	X	.	-	-	-
⚡ Golf E (2014>)	X	.	X	.	-	-	-
Golf 4 (1997 - 2003)	X	.	X	.	-	-	-
Golf 4 Variant (1996 - 2006)	X	.	X	.	-	-	-
Golf Hatch Mk5 (2004 - 2008)	X	.	X	.	-	-	-
Golf Mk5 (2006 - 2009)	X	.	X	.	-	-	-
Golf Hatch (2008 - 2012)	X	.	X	.	-	-	-
Golf Hatch MK7 (2012>)	X	.	X	.	-	-	-
Golf Cabriolet (2009 - 2012)	X	.	-	.	-	-	-
⚡ Golf GTE Hatch Mk7 (2014 - 2017)	X	.	X	.	-	-	-
Golf (2017>)	X	.	X	.	-	-	-
Golf Plus (2009 - 2013)	X	.	X	.	-	-	-
Golf Sportsvan (2017>)	X	.	X	.	-	-	-
Jetta (2010 - 2014)	X	.	X	.	-	-	-
Lupo (1999 - 2005)	X	.	-	.	-	-	-
LT (1999 - 2006)	X	.	X	.	-	-	-
Multivan (1999 - 2003)	X	.	X
Multivan (2003>)	X	.	X
Multivan Caravelle (2008>)	X	.	-	.	.	X	.
New Beetle (1998 - 2002)	X	.	X	.	-	-	-
Passat (1996 - 2005)	X	.	X	.	-	-	-
Passat (2005 - 2010)	X	.	X	.	-	-	-
Passat (2010 - 2015)	X	.	X	.	-	-	-
Passat Estate (2005 - 2011)	X	.	X	.	-	-	-
Passat Estate (2011 - 2015)	X	.	X	.	-	-	-
🚐 Passat Estate (2015>)	X	.	X	.	-	-	-
🚐 Passat Saloon (2015>)	X	.	X	.	-	-	-
Passat Alltrack (2012 - 2015)	X	.	X	.	-	-	-
Passat CC (2008 - 2011)	X	.	X	.	-	-	-
Phaeton (2002 - 2015)	X	.	X	.	-	-	-
Polo 3 (1994 - 2001)	X	.	X	.	-	-	-
Polo 4 (2005 - 2009)	X	.	X	.	-	-	-

Polo 5 (2009 - 2014)	X	•	X	•	-	-	-
Polo 3dr (2009 - 2014)	X	•	X	•	-	-	-
Polo 5dr (2009 - 2014)	X	•	X	•	-	-	-
Polo 5dr (2014 - 2017)	X	•	X	•	-	-	-
Scirocco (2008 - 2014)	X	•	-	•	-	-	-
SB! Sharan (1996 - 2000)	X	•	•	•	•	-	•
SB! Sharan (2000 - 2010)	X	•	•	•	-	-	-
SB! Sharan (2010>)	X	•	•	•	•	X	•
T4 Caravelle (1995 - 2003)	X	•	•	X	X	X	X
T5 Kombi (2003 - 2010)	X	•	•	X	-	-	-
Tiguan (2007 - 2016)	X	•	X	•	-	-	-
 Tiguan (2016>)	X	•	X	•	-	-	-
Touareg (2002 - 2010)	X	•	X	•	-	-	-
Touareg (2010 - 2014)	X	•	X	•	-	-	-
Touareg (2018>)	X	•	X	•	-	-	-
Touareg MK 1 (2003 - 2010)	X	•	X	•	-	-	-
Touran (2003 - 2010)	X	•	X	•	-	-	-
SB! Touran (2010 - 2015)	X	•	X	•	X	-	X
Touran (2015>)	X	•	•	•	X	-	X
Transporter LT3 (1996 - 2006)	X	•	X	•	-	-	-
T-ROC (2017>))	X	•	X	•	-	-	-
Transporter LT3 (2006)	X	•	X	•	-	-	-
T-Roc (2018 >)	X	•	X	•	-	-	-
UP! (2011 - 2016)	X	•	X	•	-	-	-
⚡ E - UP! (2014 - 2016)	X	•	X	•	-	-	-
⚡ E - UP! 3dr (2016>)	X	•	X	•	-	-	-
⚡ E - UP! 5dr (2016>)	X	•	X	•	-	-	-